



Dual External Transmission Oil Cooler Kit Suitable for:



**Ford Everest UA 6 Speed 6R80
Ford Everest UA 10 Speed 10R80
Automatic Transmissions**

WITH THE FOLLOWING ENGINES:

Duratorq P5AT - 3.2L Turbo Diesel - 2015 to Present
Duratorq ZSD-422 - 2.2L Turbo Diesel - 2015 to Present
EcoBlue 2.0L Bi Turbo Diesel - 2018 to Present

Please read through all of the instructions carefully before proceeding. If any of the information does not appear correct or the diagrams don't match your vehicle, please contact Wholesale Automatic Transmissions on +61 3 9762 8004.

Parts List

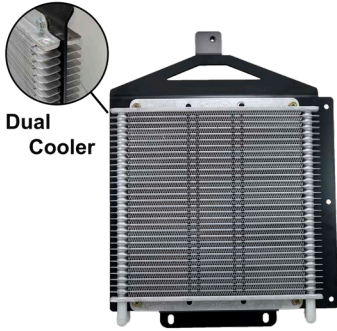

1 x Dual Cooler Bracket
with coolers fitted



1 x J-Pipe with Rubber
Lined P-Clamp



5m x High Temp Cooler
Line Hose with Conduit

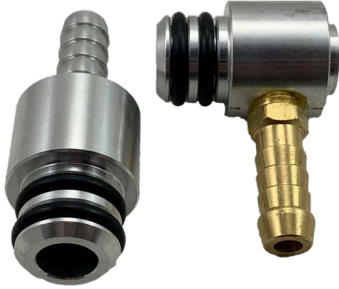

1 x Straight Union
1 x Right Angle Union



2 x M6 x 20 SEMS Bolt
2 x Metal Self Tappers



6 x 8-16 Screw Clamps
2 x 14-27 Screw Clamps



1 x Union Support
Bracket for 10R80 only



1 x Dual Cooler
Link Hose



1 x Wind Deflector Wing
3 x M6x16 SEMS Bolts

Expected Installation Time: 5 Hours

Summary of Installation - For Experienced Fitters

- SAFETY FIRST: Allow engine, auto and fluid to cool prior to starting work to prevent serious injury.
- Remove top grill cover, front grill and bash plates
- Unbolt shroud and cut off passenger side of centre hole. Drill new hole for clip.
- Remove horn bracket.
- Fit the Link Hose and the 5m length of cooler hose to coolers. Secure with four (4) supplied 8-16 screw clamps.
- Fit the top bolt by locating mounting bracket behind radiator support panel into the hole approx 100mm to the right of the bonnet latch.
- Check that the cooler and bracket have plenty of clearance and that the bracket is sitting straight, then install the lower two self tapping screws. Possibly use lower shroud mounting bolt if hole lines up in bracket.
- Cable tie cooler lines as you work your way to the heat exchanger mounted to the passenger side of the auto, just above the prop shaft. Allow for engine oil filter to be removed for engine maintenance when you are cable tying the lines.
- Use hose clamp pliers to clamp the 2 x black coolant hoses connected to the heat exchanger.
- **6R80 only:** Remove four (4) T40 Torx bolts or 10mm hex head bolts to remove heat exchanger. Do not discard bolts or bracket.
- **6R80 only:** Fit Custom Cooler unions to transmission and secure with flat bracket & bolt removed from heat exchanger. Right angle union to top location.
- **10R80 only:** Remove three (3) T40 Torx bolts if you can. You may need to drop crossmember to remove bolts. Remove heat exchanger. Do not discard bolts. Refit Crossmember. Fit Custom Cooler unions to transmission and secure with supplied union support bracket & a bolt removed from heat exchanger.
- Fit J-Pipe to coolant hoses and clamp with the supplied two (2) 14-27 screw clamps and release hose clamp pliers. Use P-Clamp to secure J-Pipe to a vacant bolt hole.
- Cable tie lines in place and then cut cooler lines to length leaving a little slack for movement. Fit cooler lines using two (2) supplied 8-16 screw clamps.
- If needed, top up coolant and/or transmission fluid with the recommended fluid
- Test drive vehicle for 15mins and then check all hoses and fittings leaks. Recheck mounts and bolts are tight. Re-check fluid levels.
- Refit any bash plates, grills, aftermarket accessories removed.

Detailed Installation Instructions

Before Commencing work, please ensure that you have sufficient transmission fluid and engine coolant to top up at the end of the job. Please read through all of the instructions as there may be multiple ways to fit the bracket depending on which vehicle variant you have.

1. Open bonnet.
2. Remove the top grill cover above the front grill by removing the (5) plastic clips in addition to removing the (2) 10mm head bolts located on the driver side of the vehicle.

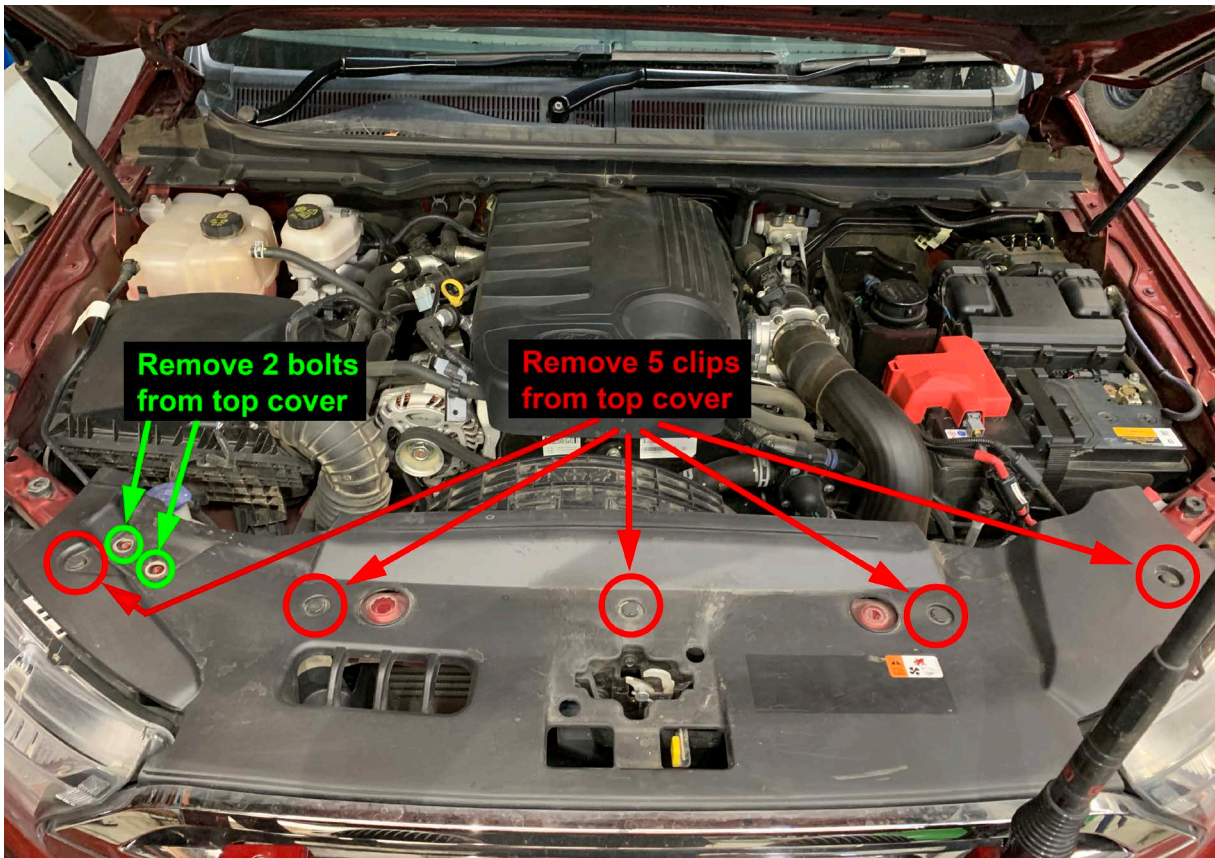

3. Remove the front grill by unscrewing the (2) Phillips head screws located at the top of either end of the grill. Carefully release the tabs along the bottom of the grill and pull it forward away from the vehicle. Lift and remove the grill taking care not to damage any part of the vehicle.



4. Remove the shroud from the bonnet release catch by removing the bolt on the drivers side and releasing the clip on the passenger side. Do not discard.

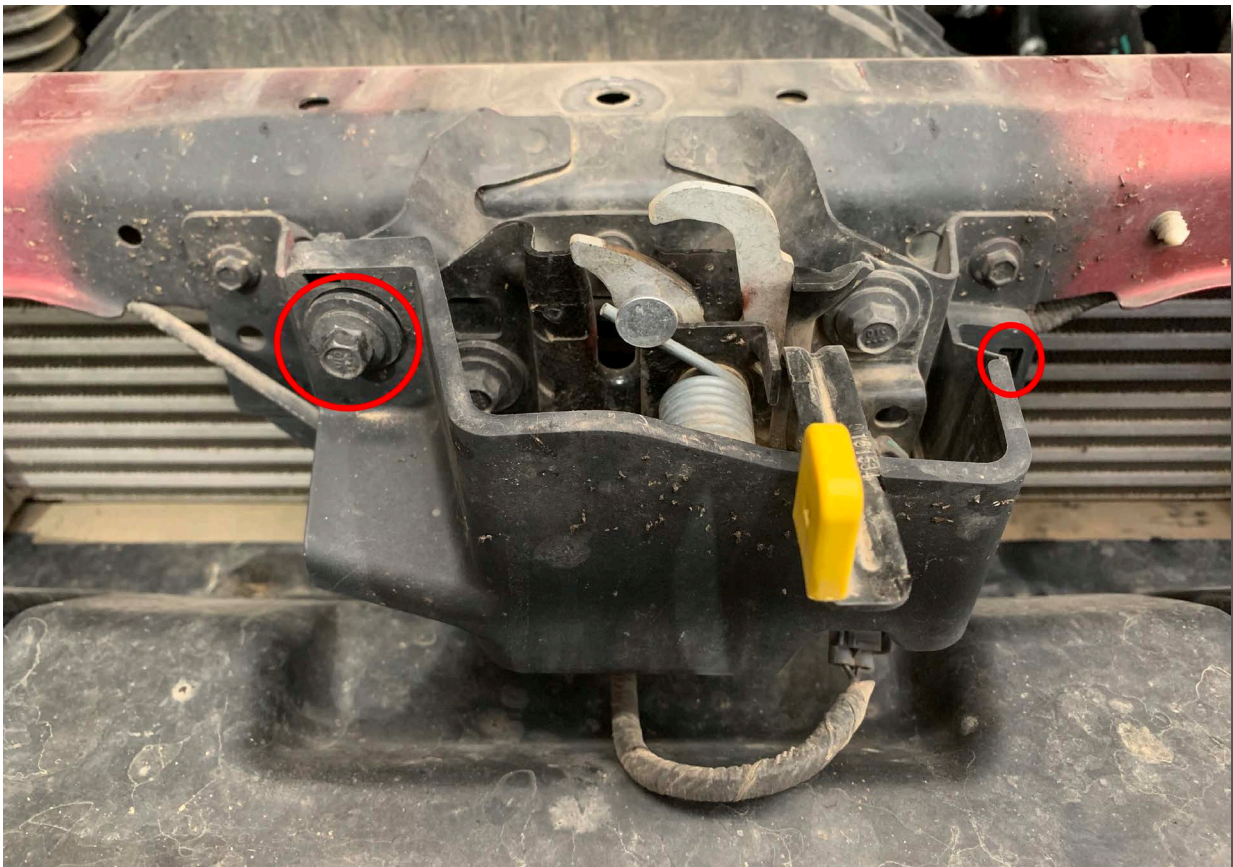

5. Remove the nut holding the horn bracket in place. Move horns out of the way while cutting the shroud. Do not discard, this will be re-installed.



6. Mark a line from front to back as shown below. The line should be on the passenger side of the hole that was used to secure the bonnet release wiring.

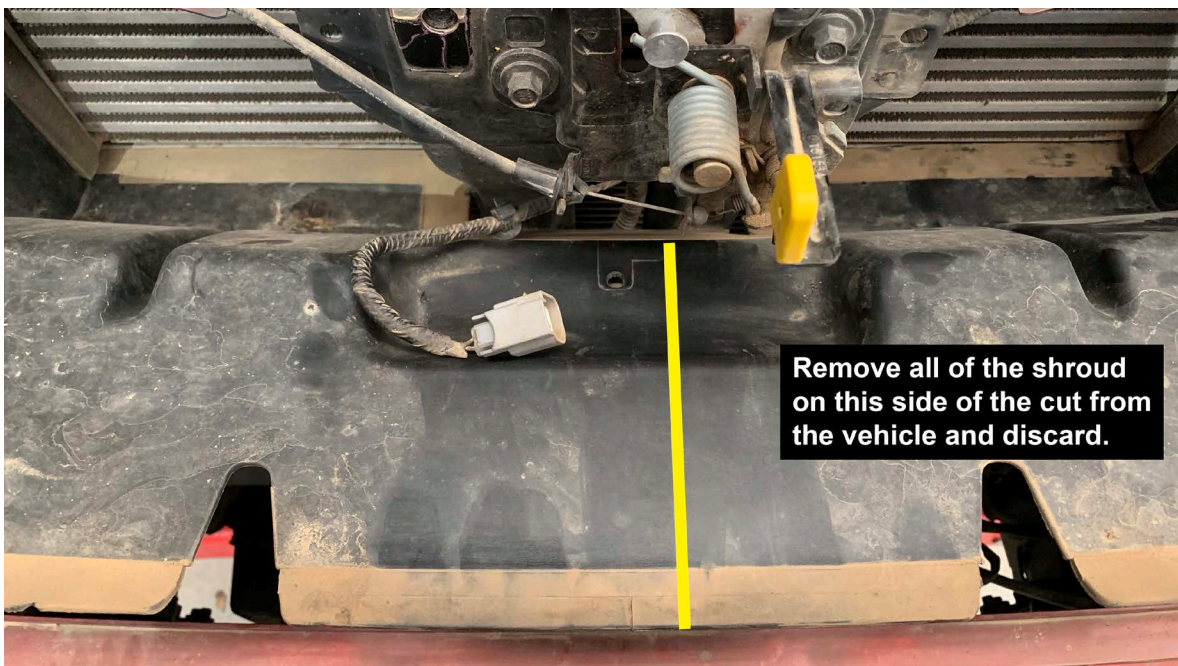

7. Remove ambient temperature sensor from passenger side of shroud.
8. Remove the bolt holding the top passenger side of the shroud in place. The bolt is located in a recess just below the passenger headlight.

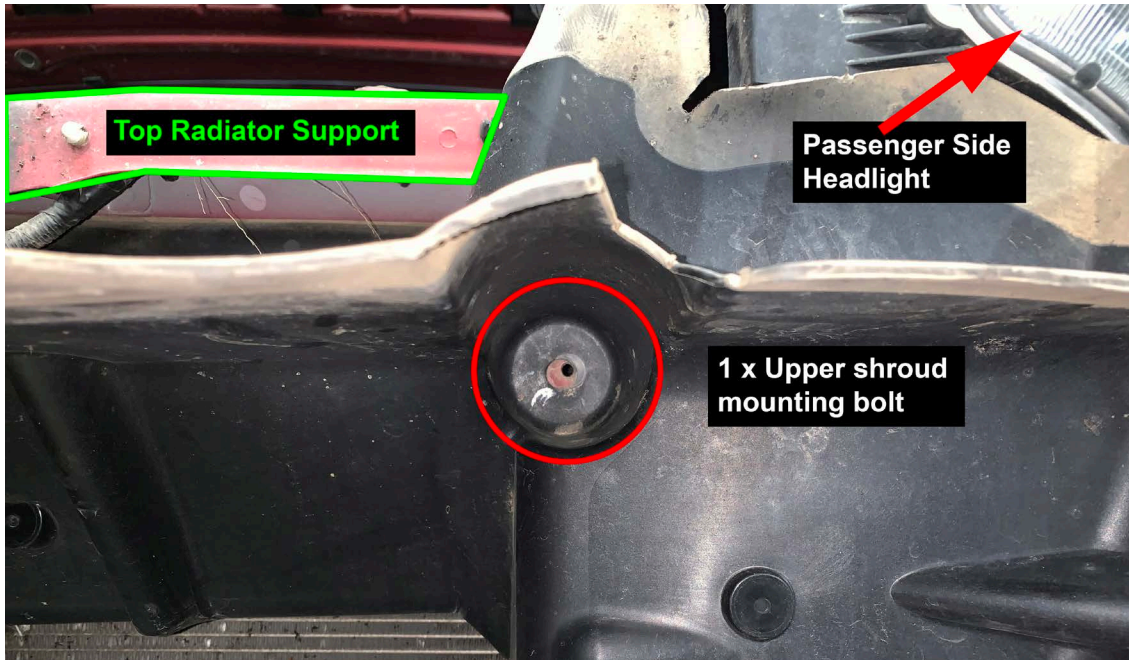

9. Remove the bolt holding the lower passenger side of the shroud in place. The bolt is located on the lower radiator support panel as shown below.

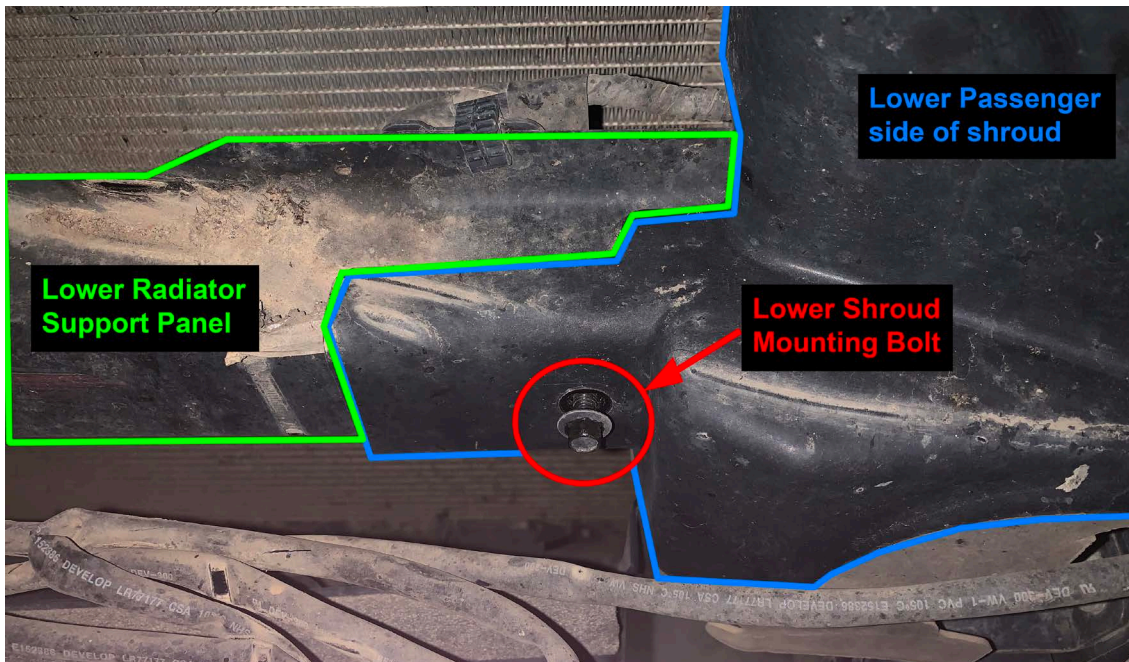

10. Lift the passenger side of the shroud forwards to provide clearance to the vehicle while cutting. Use a hacksaw blade, tin snips or blade to cut through the plastic shroud. Remove all of the shroud to the passenger side of the cut.



11. Drill an 8mm hole beside the original hole for the wiring clip. We will use the original hole for securing the shroud. The new hole is for the wiring clip.



12. We will refit the remaining shroud and horns in a later step.

13. Mount the Wind Deflector Wing to the side of the cooler bracket using 3 x M6x16 SEMS bolts and tighten.

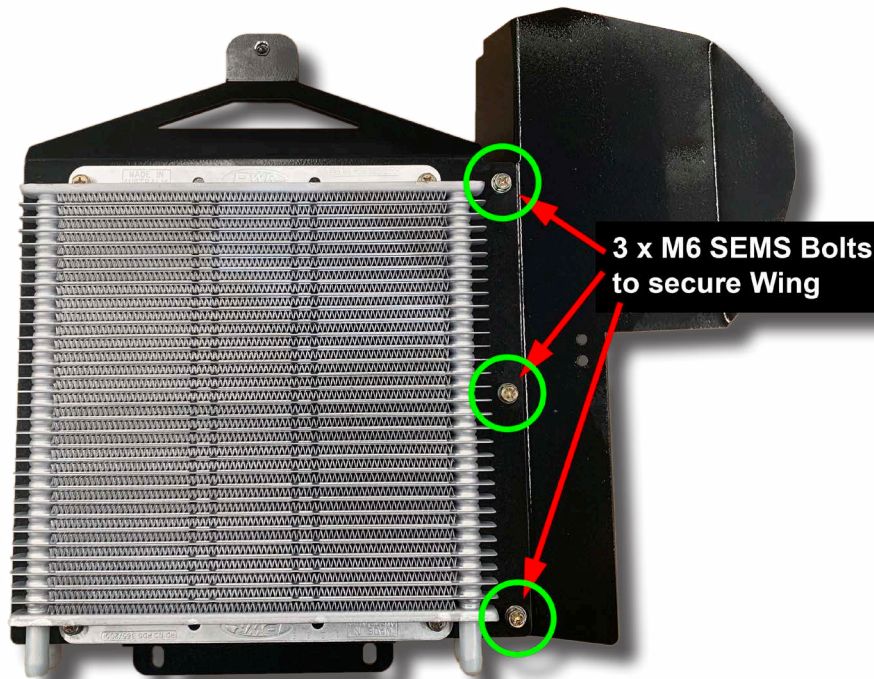

14. Fit the Dual Cooler Link Hose to the left side fitting of the front cooler. The other end to the right side fitting of the rear cooler. Secure with two (2) screw clamps. Loop the 5m long length of cooler hose in half and fit the ends to each of the remaining cooler fittings. Do Not Cut Loop Yet. The coolers are multi-directional so it does not matter which cooler hose goes where.

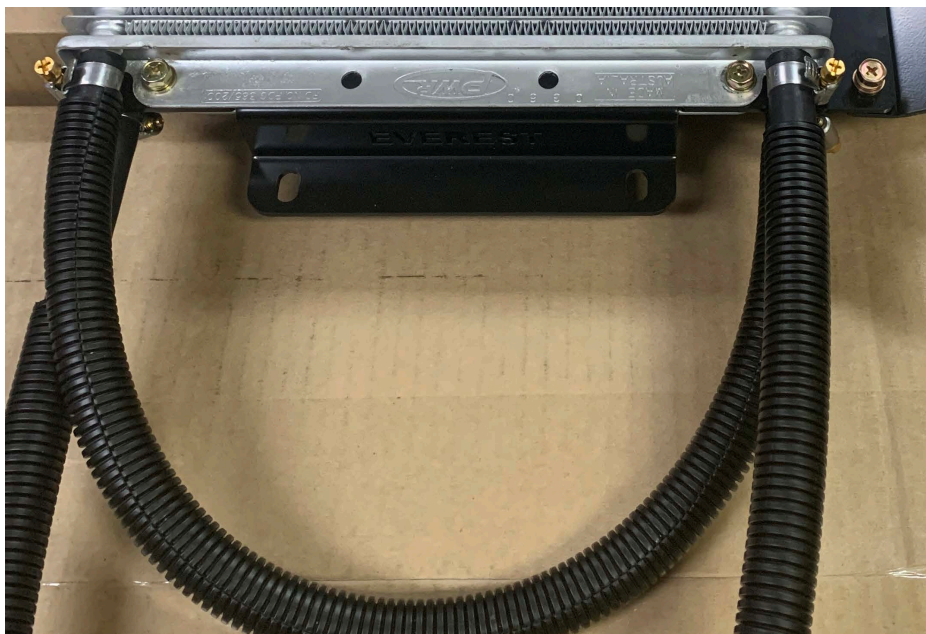

15. Lower the cooler assembly into the vehicle and place top of bracket behind radiator support panel, lined up with existing hole. Using 1 x M6x20 SEMS bolt, secure bracket to radiator support panel.

The two (2) self tapping screws should be used to attach the bottom of the cooler to the radiator support.

Note* In some vehicle variants, the thread in the lower support panel will line up with the hole on the lower right of the cooler bracket. If yours lines up, please use the original bolt removed from the shroud and secure. If yours doesn't line up, please use both self tapping screws to secure bottom of bracket.



16. Re-Install the two (2) original drivers side shroud fixings. Using the supplied Shroud Mounting Bracket, fit onto the stud for the horn bracket then re-fit horn bracket and finger tighten with original nut. With supplied M6x20 SEMS bolt, fit through existing hole in shroud into the thread in the Shroud Mounting Bracket. Tighten both nut and bolt.

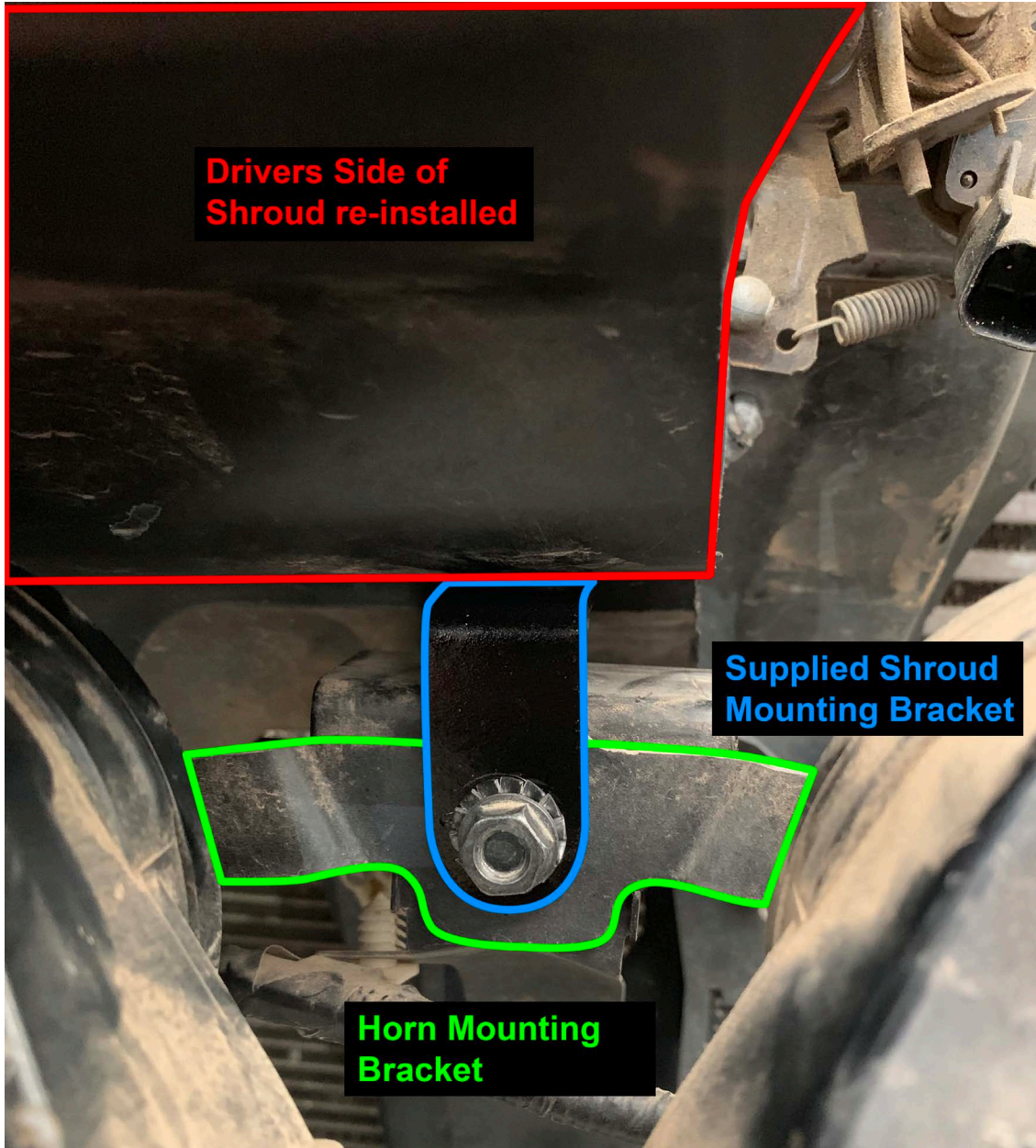

17. Fit ambient air temperature sensor to the two (2) holes in the Wind Deflector Wing.

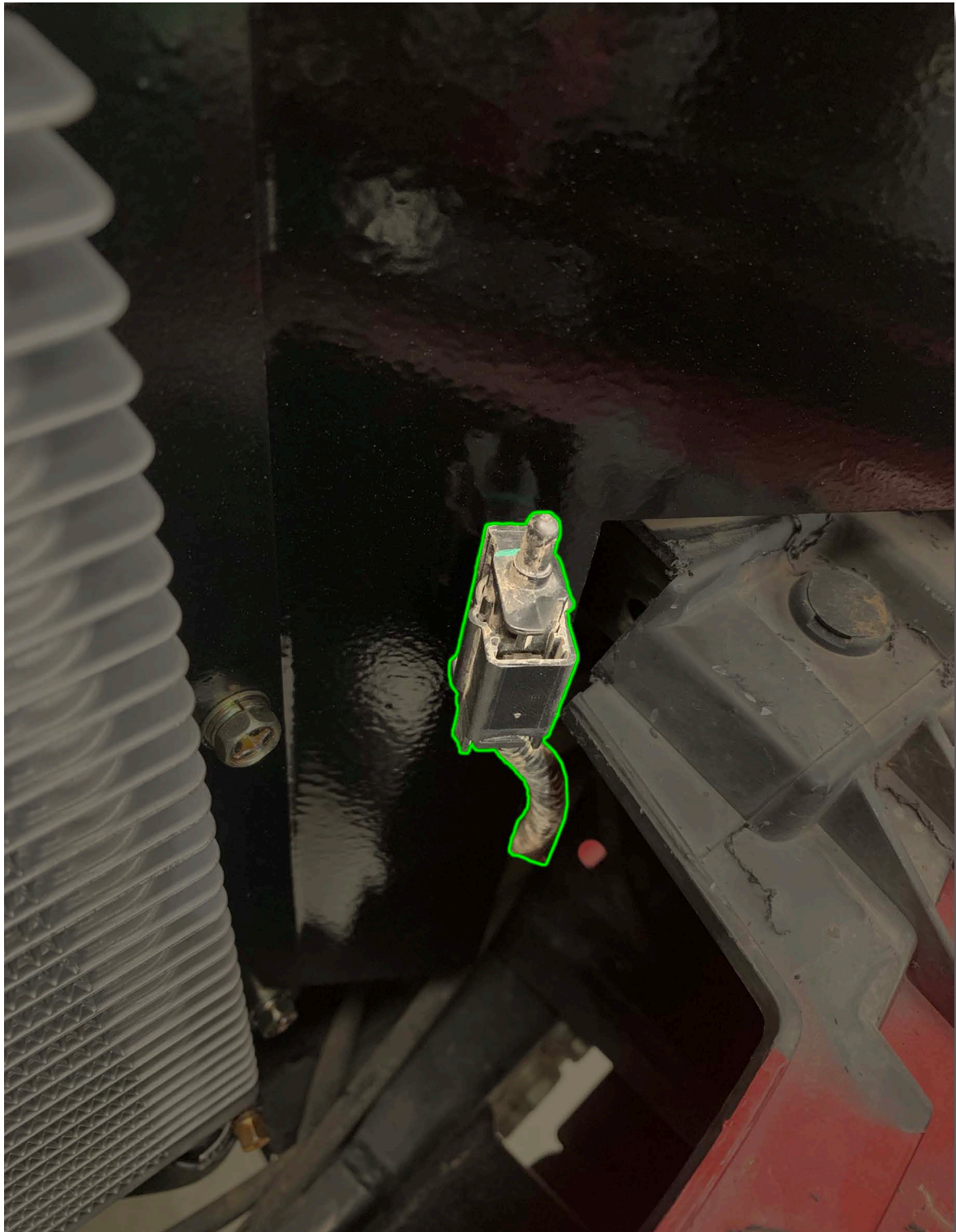

18. Route cooler lines along the passenger chassis rail, make sure they are clear of any hot or moving vehicle components. Cable tie cooler lines firmly to the vehicle but not too firm that they cause flow restrictions and so that they are not too tight between tie points. Ensure the cooler lines do not prevent access to the engine oil filter by cable tying them to the air con lines above the engine oil filter.

The lines need to reach the area on the passenger side of the automatic, just above front prop shaft. (Do not cut the hose yet)

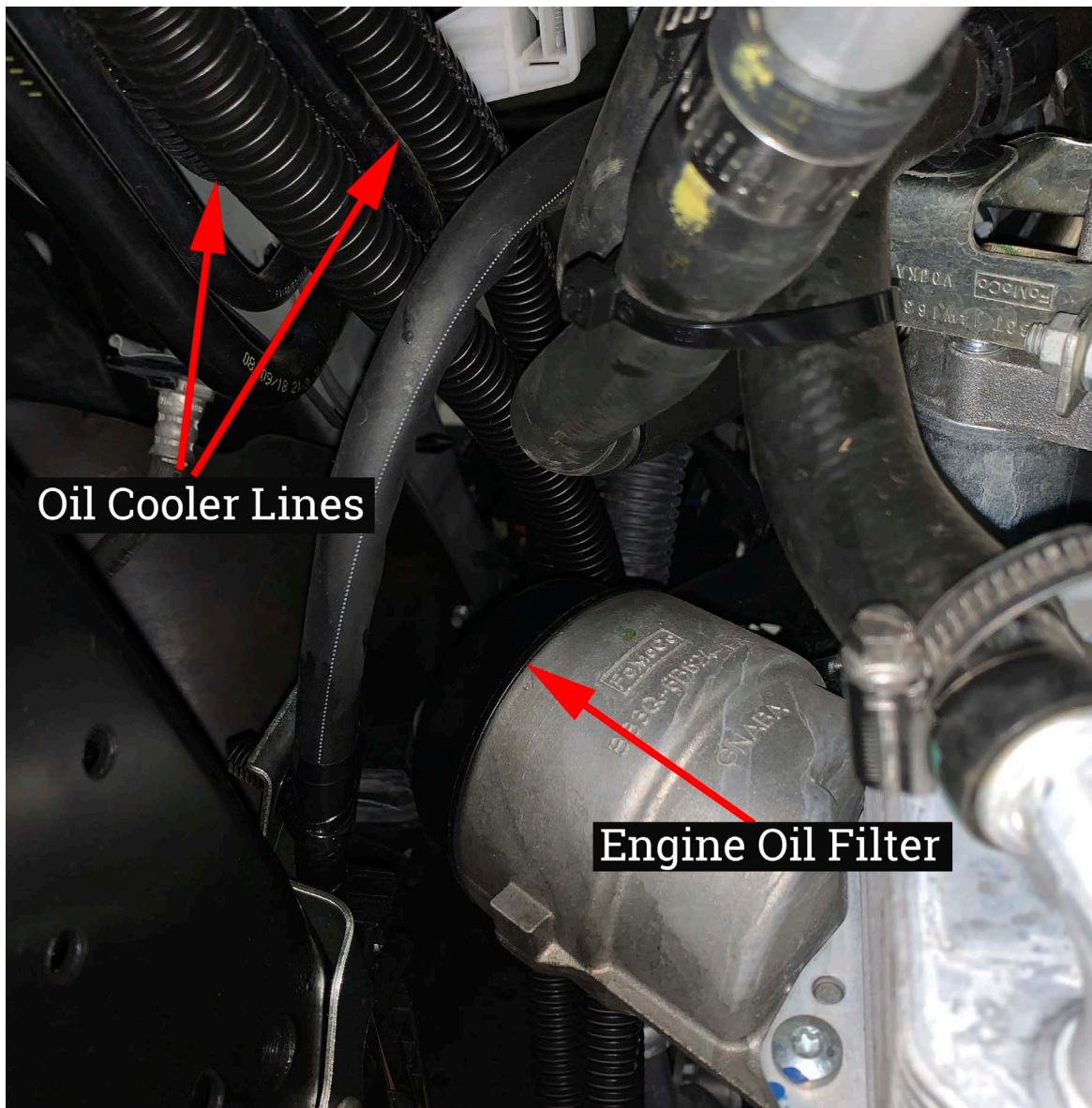

- Using two hose clamps, clamp off the two coolant hoses that connect to the heat exchanger to prevent radiator fluid draining out.



20. Remove coolant hose clamps and then remove the hoses from the heat exchanger. Make sure you have a drain tin or bucket under the hoses to catch the small amount of radiator fluid that will drop out.

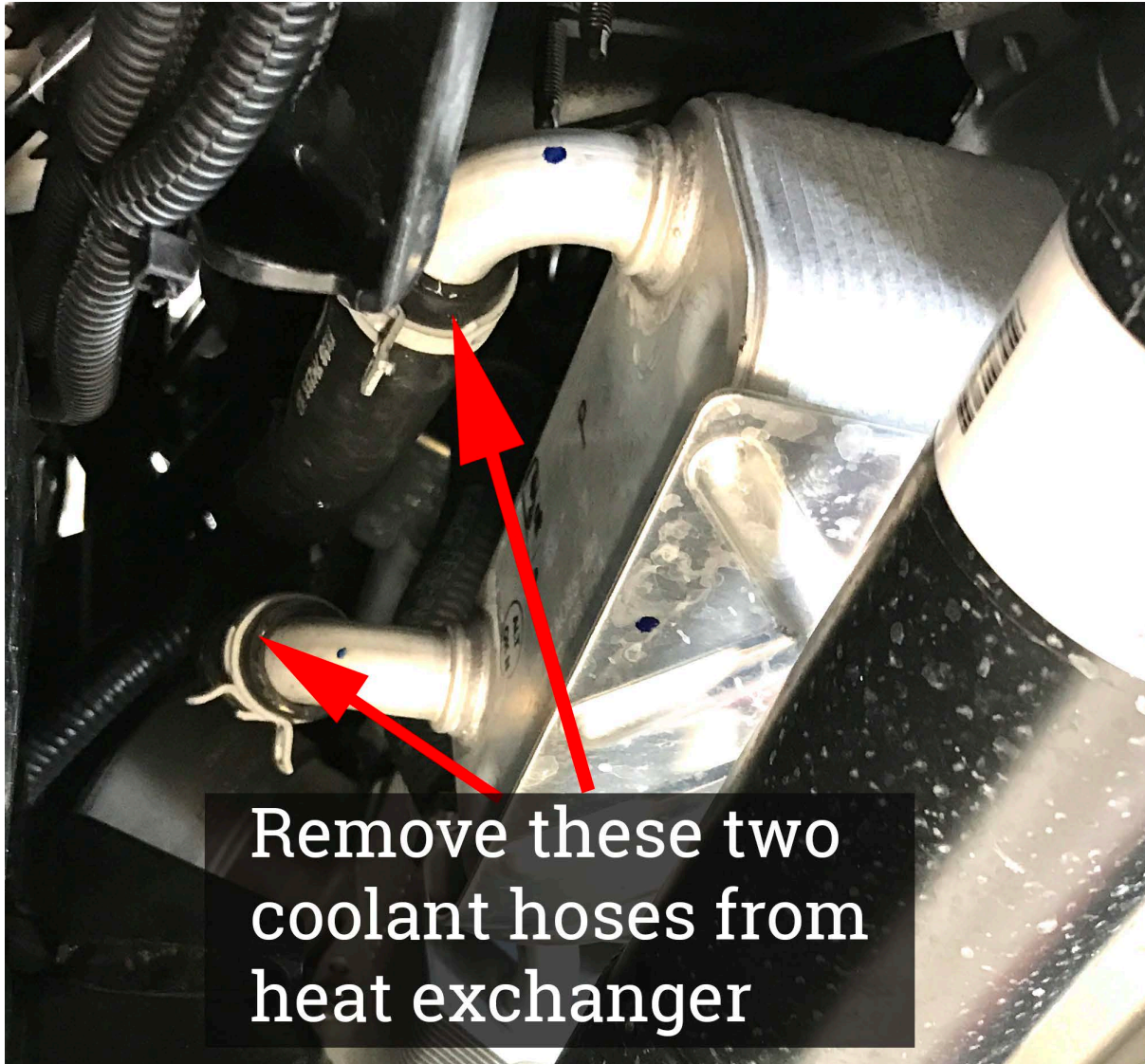

6 Speed Heat Exchanger Removal:

21. Remove the two split pins from the cooler union support bracket and unbolt the torx bit (10mm Bolt on early models) holding the bracket in place. Remove the support bracket but don't discard as we will reuse this bracket.



22. Unbolt heat exchanger by removing the three bolts holding it to the transmission. Two bolts are above the heat exchanger and one bolt below. All three bolts are either T40 Torx on newer models or 10mm hex head on older models. Do not discard the bolts.

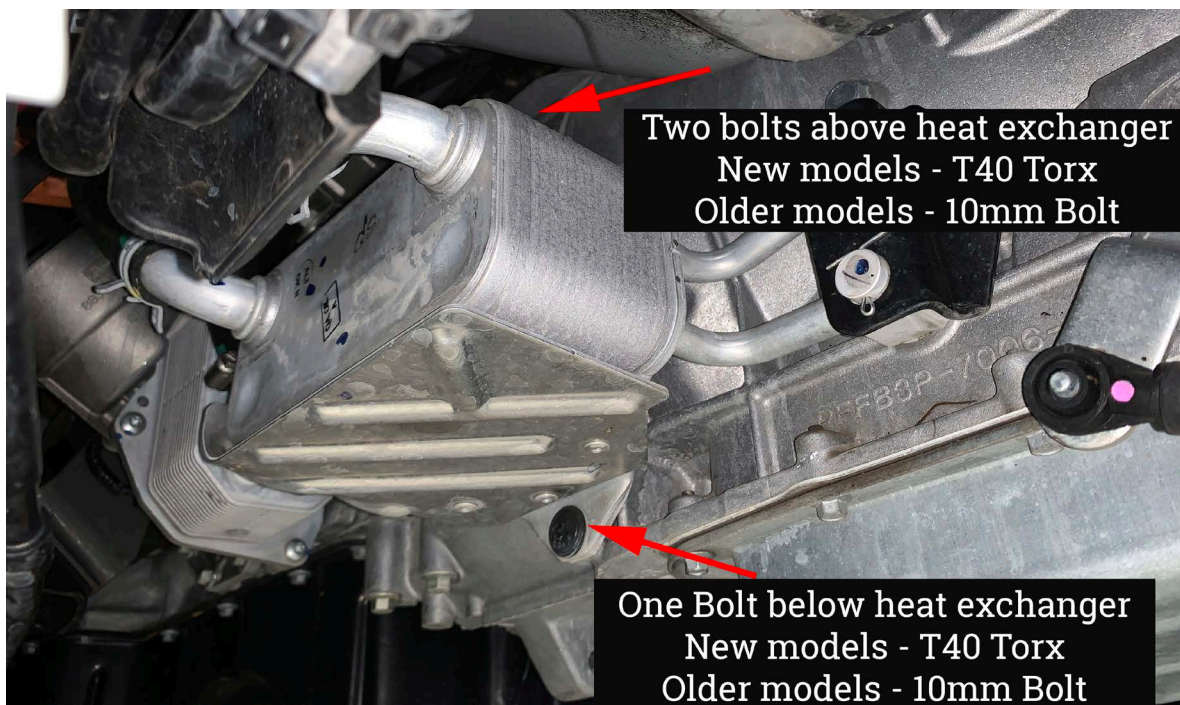

Two bolts above heat exchanger
New models - T40 Torx
Older models - 10mm Bolt

One Bolt below heat exchanger
New models - T40 Torx
Older models - 10mm Bolt

23. Remove the heat exchanger by gently removing the two union lines from the auto first, then the exchanger should be free from the auto. Have a drain tin or bucket underneath as some transmission fluid may come out. If you can't get the heat exchanger past the drive shaft, you may need to cut off the lines coming out of the heat exchanger.
24. Check that both custom made unions have two (2) o-rings fitted prior to installing. Run a small covering of transmission fluid around both o-rings on both unions to provide lubrication.

Install the unions by carefully inserting them into the openings left by the heat exchanger. Due to some vehicle variants having rear air con, we have supplied a right angle cooler union for the top hole to provide clearance to the air con lines. Secure the new unions with the factory support bracket previously removed and secure using one of the T40 torx bolts (or 10mm hex head bolts).

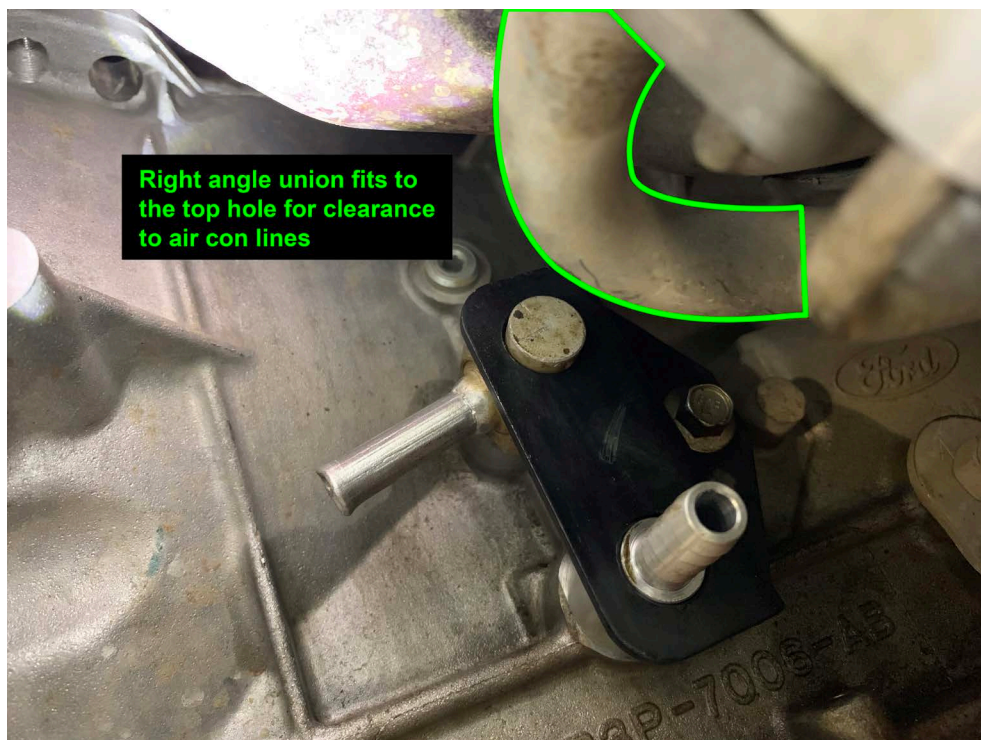

*Note: If installing with a transmission temperature gauge, the union to use for for the temperature sensor (Hot Line) is the lower union.

10 Speed Heat Exchanger Removal:

25. Using a T40 torx bit, remove the three bolts holding the heat exchanger to the transmission. Don't discard the bolts.
The top two bolts are extremely difficult to access. If your tooling doesn't provide you access to these bolts, see next step.

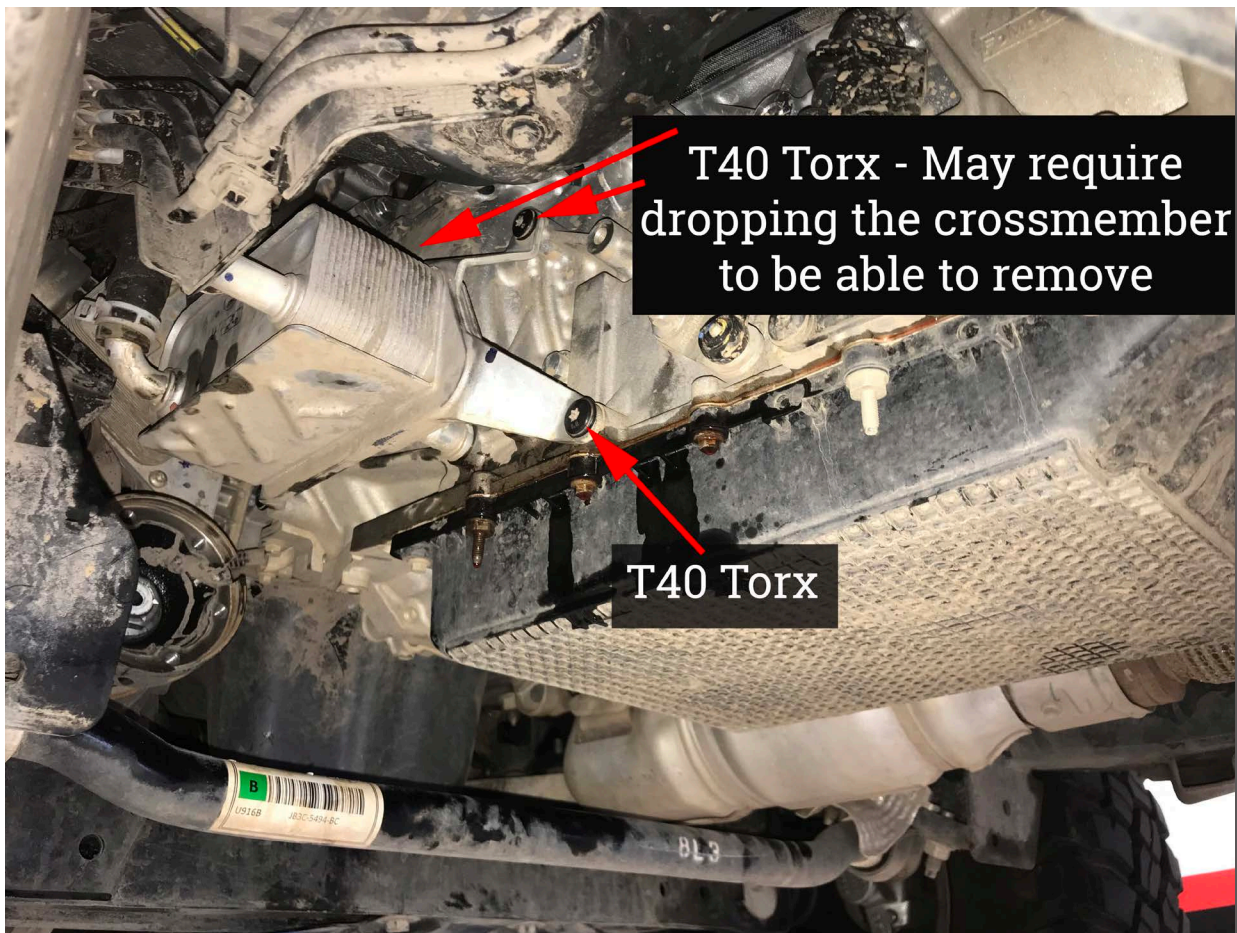

26. If you can't access the top torx bolts, you may need to lower the crossmember. First, you will need to support the transmission with a transmission jack or adjustable support before unbolting the crossmember.

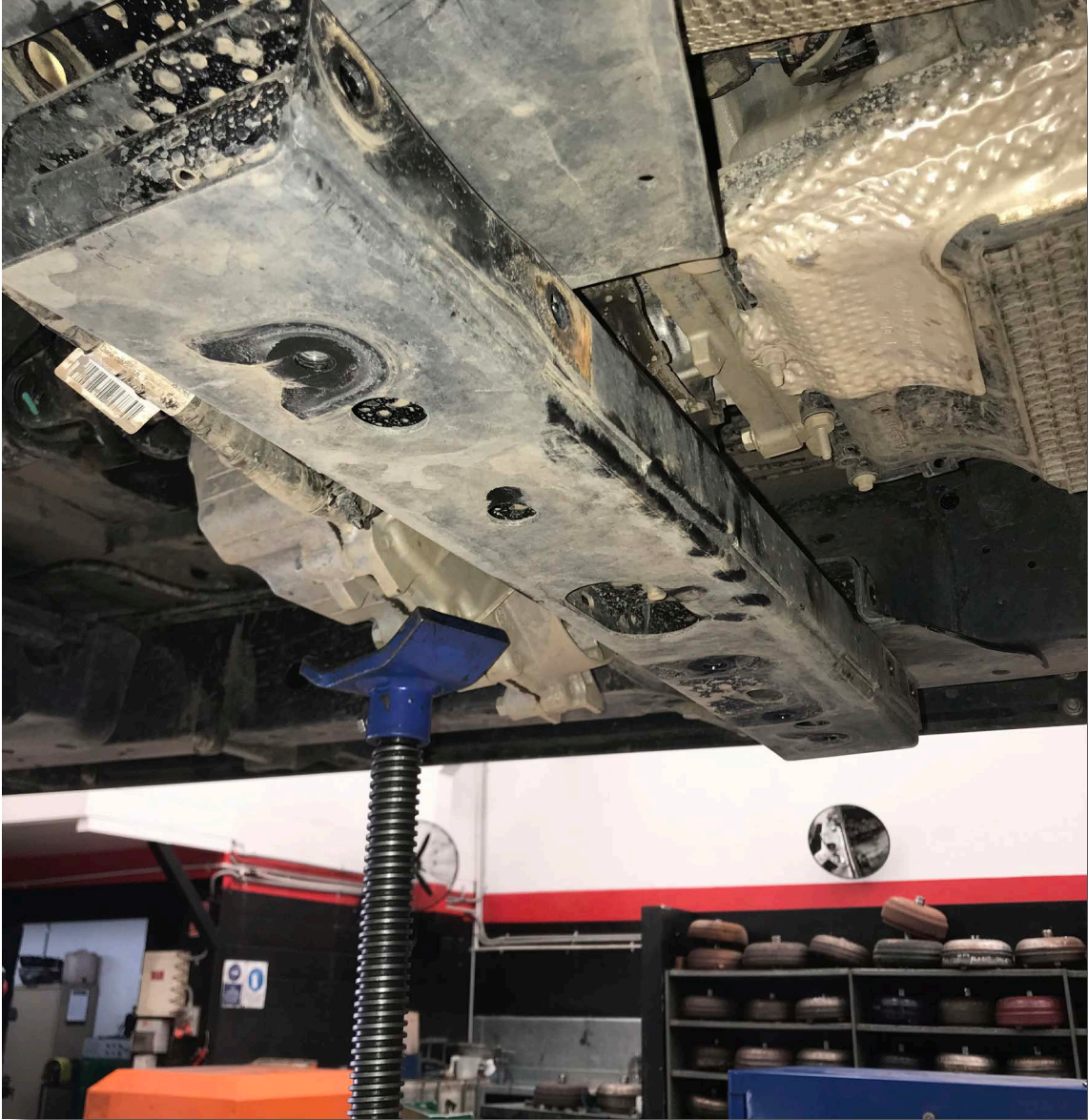

27. Start by unbolting the exhaust mounting on the drivers side above the crossmember and remove the nuts from the four (4) crossmember bolts.

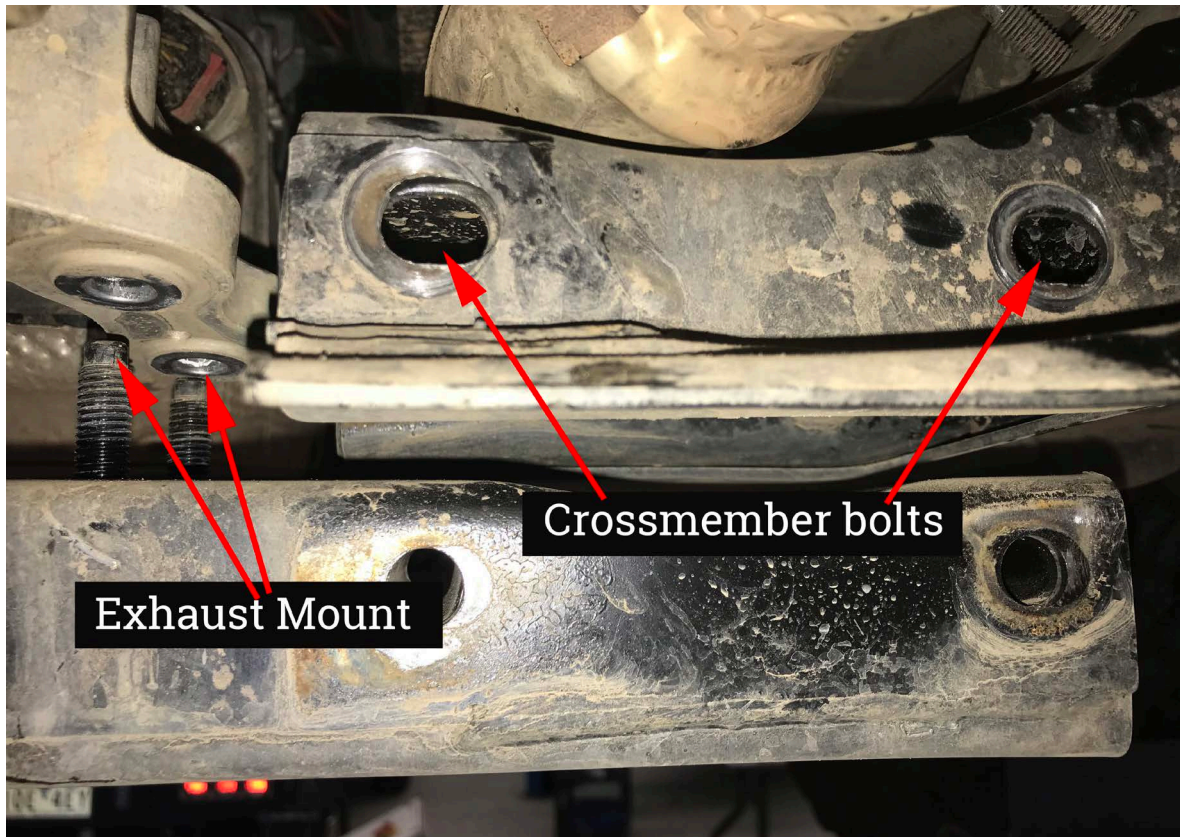

28. Take the weight of the transmission and crossmember on the transmission jack/support so that you can remove the crossmember bolts completely. You may also need to remove four (4) crossmember bolts holding the K part of the crossmember. Once the bolts are removed, slowly lower the transmission and crossmember down approx 50mm while monitoring any wiring or hoses that might get snagged.

29. With the transmission lowered, you will now be able to access the top two torx bolts on the heat exchanger. Don't discard the bolts.



30. Gently remove the heat exchanger from the transmission by pulling it horizontally away from the transmission. Have a drain tin or bucket underneath as some transmission fluid may come out.

31. Install the two supplied custom cooler unions. Check that both unions have two (2) o-rings fitted prior to installing. Run a small covering of transmission fluid around both o-rings on both unions to provide lubrication.

NOTE**

While the 6 Speed requires a right angle union due to the orientation of the holes being up and down, the 10 speed does not. However to make the one kit fit both, we have supplied 1 x straight union and 1 x right angle union. For the 10 speed, it does not matter which union fits where.

Install the unions by carefully inserting them into the openings left by the heat exchanger. Secure the new unions with the supplied bracket using one of the T40 torx bolts removed previously.



*Note: If installing with a transmission temperature gauge, the union to use for for the temperature sensor (Hot Line) is the rear union.

The remainder of the instructions applies to both transmissions.

32. Fit J-Pipe to coolant hoses and push in as far as possible. Test that you can easily manouvre the J-Pipe near one of the heat exchanger vacant bolt holes for sercuring the J-Pipe after fitment. Clamp the coolant hoses using the two (2) supplied large screw clamps.
33. Secure the J-Pipe to one of the heat exchanger vacant bolt holes using the previously remove T40 torx bolt (10mm hex head bolt).



34. Check the routing of the cooler lines prior to cutting to ensure they will not impact on any part of the vehicle or could become jammed or pinched. Cable tie them so they keep sufficient clearance around the Engine Oil Filter for ease of engine maintenance.
35. Measure where they need to be cut for the unions while allowing for some slack between the unions and the first cable tie point.

36. Cut rubber cooler lines to length and pull back the conduit. Slide the remaining small screw clamps onto the cooler hose and then insert the hoses onto the unions. Do not use any lubricant on the barbed fittings. Re-fit conduit into place, trim if necessary.

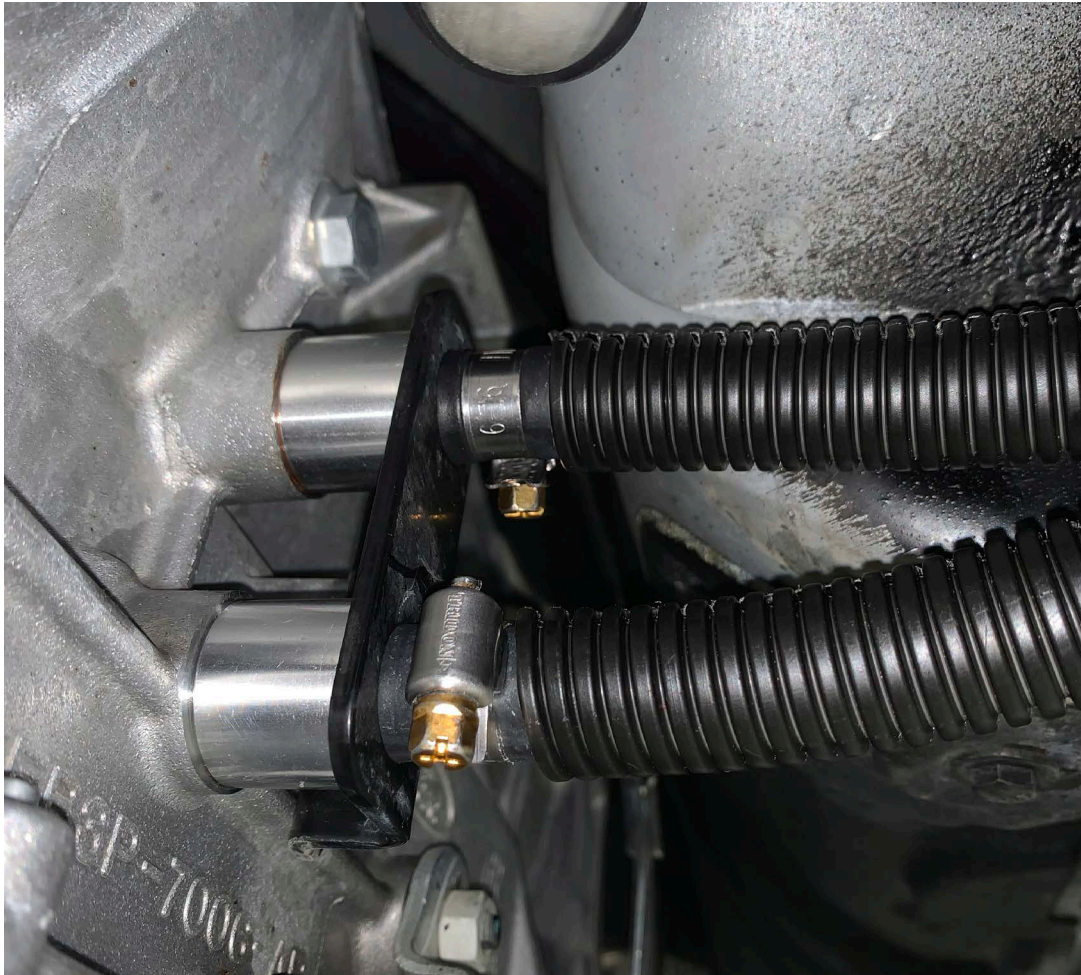

37. Check clearance of hoses to front prop shaft. Cable tie the coolant hoses to prevent rubbing.

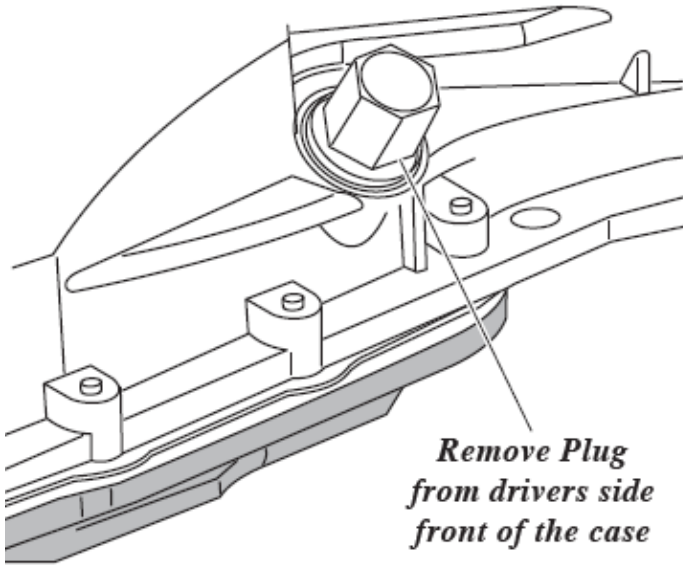
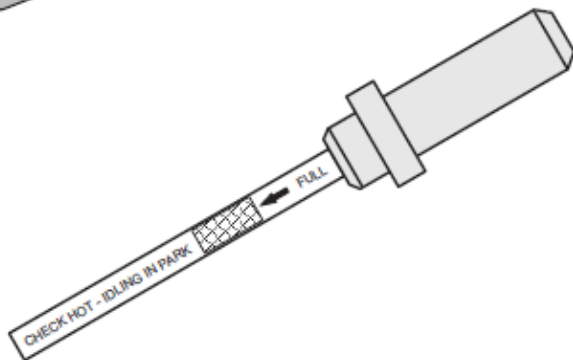
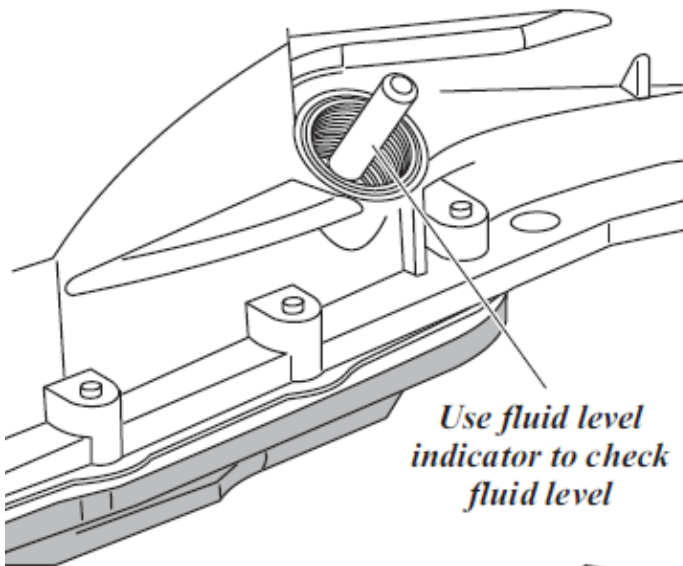

38. Re-Install crossmember to correct position and secure with original bolts.
39. Recheck transmission coolers, fittings, hoses, unions, mountings and clamps for any leaking or loose fittings. Tighten if necessary.
40. Check the transmission fluid level and if necessary, top up with Genuine Transmission Fluid or any full synthetic transmission fluid that meets or exceeds the genuine oil specification.
41. Check engine coolant level and top up with the manufacturers recommended coolant.
42. Clean any spilt engine coolant or transmission fluid from under the vehicle so that it is easy to detect a leak. You can use brake cleaner as it will evaporate quickly. Avoid spraying exhaust and body work with brake cleaner or solvent.
43. Road test vehicle for a minimum of 15 minutes. Try to find a couple of hills that will get the transmission to work hard.
44. Check the transmission coolers, fittings, hoses, unions, mountings and clamps for any leaking or loose fittings. Tighten if neccessary.
45. Check engine coolant level and transmission fluid level again.
46. If step 34 required tightening of any part or if Step 35 resulted in coolant or transmission fluid showing low, repeat steps 31 to 35
47. Refit any bash plates, front grills, aftermarket accessories that were removed during the fitment of the cooler kit.

FLUID FILL PLUG**FLUID LEVEL INDICATOR**

Check fluid level hot idle in park
80° - 85°C (175° - 185°F)

The recommended
transmission fluid for
the Ford 6R80 6 Speed
is Mercon LV[©]

The recommended
transmission fluid for
Ford 10R80 10 Speed
is Mercon ULV[©]

This completes the installation of the Dual External Transmission Oil Cooler Kit: Ford Everest 6 Speed and Ford Everest 10 Speed

Please remember ALL automatic transmissions have a service interval of
2 years or 40,000km to improve the longevity of the transmission.