



Dual External Transmission Oil Cooler Kit Suitable for:



**Ford Ranger PX 6 Speed 6R80
Mazda BT50 6 Speed 6R80
Ford Ranger PX 10 Speed 10R80
Automatic Transmissions**

WITH THE FOLLOWING ENGINES:

**Duratorq P5AT - 3.2L Turbo Diesel - 2011 to Present
Duratorq ZSD-422 - 2.2L Turbo Diesel - 2011 to Present
EcoBlue 2.0L Bi Turbo Diesel - 2018 to Present**

Please read through all of the instructions carefully before proceeding. If any of the information does not appear correct or the diagrams don't match your vehicle, please contact Wholesale Automatic Transmissions on +61 3 9762 8004.

Parts List

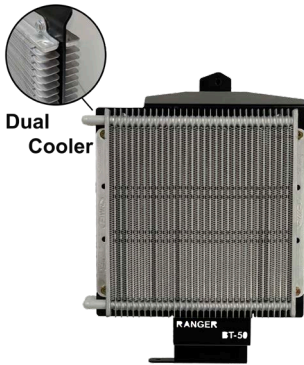

1 x Dual Cooler Bracket
with coolers fitted



1 x J-Pipe with Rubber
Lined P-Clamp



5m x High Temp Cooler
Line Hose with Conduit



2 x Custom Cooler
Unions with O-Rings



1 x M6 x 20 SEMS Bolt
2 x Metal Self Tappers



6 x 8-16 Screw Clamps
2 x 14-27 Screw Clamps



1 x Union Support
Bracket for 10R80 only



1 x Dual Cooler
Connection Hose

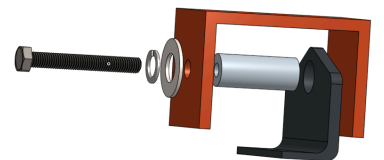

1 x Optional top mount
bolt spacer kit

Expected Installation Time: 3 Hours

Summary of Installation - For Experienced Fitters

- **SAFETY FIRST:** Allow engine, auto and fluid to cool prior to starting work to prevent serious injury.
- Remove Front Grill and bash plates
- Fit the Connector Hose to the upper union of the front cooler and the lower union on the rear cooler. Secure with two (2) supplied 8-16 screw clamps.
- Fit the 5m Cooler line to the Cooler with two (2) supplied 8-16 stainless steel screw clamps before lowering into position unless you have go-go gadget fingers.
- Fit the top bolt by locating mounting bracket behind radiator support panel into the hole approx 100mm to the right of the bonnet latch. Optional top mount spacer kit.
- Check that the cooler and bracket have plenty of clearance and that the bracket is sitting straight, then install the lower two self tapping screws.
- Cable tie cooler lines as you work your way to the heat exchanger mounted to the passenger side of the auto, just above the prop shaft. Allow for engine oil filter to be removed for engine maintenance when you are cable tying the lines.
- Accessing through passenger wheel arch, use hose clamp pliers to clamp the 2 x black coolant hoses connected to the heat exchanger.
- **6R80 only:** Remove four (4) T40 Torx bolts or 10mm hex head bolts to remove heat exchanger. Do not discard bolts or bracket. Fit Custom Cooler unions to transmission and secure with flat bracket & bolt removed from heat exchanger.
- **10R80 only:** Remove three (3) T40 Torx bolts if you can. You may need to drop crossmember to remove bolts. Remove heat exchanger. Do not discard bolts. Refit Crossmember. Fit Custom Cooler unions to transmission and secure with supplied union support bracket & a bolt removed from heat exchanger.
- Fit J-Pipe to coolant hoses and clamp with the supplied two (2) 14-27 screw clamps and release hose clamp pliers. Use P-Clamp to secure J-Pipe to a vacant bolt hole.
- Cable tie lines in place and then cut cooler lines to length leaving a little slack for movement. Fit cooler lines using two (2) supplied 8-16 screw clamps.
- Check clearance of hoses and fittings to any other moving/hot part. If needed, top up engine coolant and/or transmission fluid with the recommended fluid
- Test drive vehicle for 15mins and then check all hoses and fittings leaks and also check mounts and bolts are tight. Clean any oil or coolant residue off vehicle. Road test. Check for leaks. Retighten if neccassary. Re-check fluid levels.
- Refit any bash plates, grills, aftermarket accessories removed.

Detailed Installation Instructions

Before Commencing work, please ensure that you have sufficient transmission fluid and engine coolant to top up at the end of the job. Please read through all of the instructions as there may be multiple ways to fit the bracket depending on which vehicle variant you have.

1. Remove the front grill of the vehicle and any bash plates that are covering/protecting the transmission and radiator.

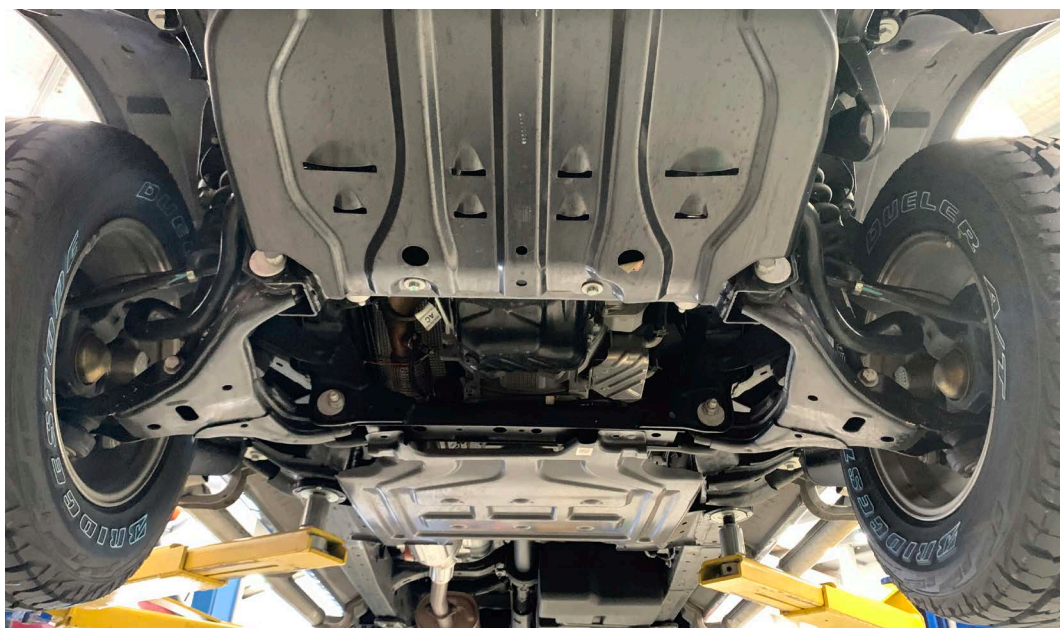

2. Face the bracket with the pre-mounted coolers towards you. Fit the Dual Cooler Connector Hose to the upper union of the front cooler and the lower union on the rear cooler. Secure with two (2) supplied 8-16 screw clamps.



3. Fit the 2 ends of the 5 metre length of cooler line hose to the remaining cooler unions using 2 x stainless steel screw clamps before lowering into position due to the lack of space. Do not cut the looped end of hose yet.
4. Feed the Cooler and hoses down into the passenger side area and hook the bracket behind the hole approx 100mm to the right of the bonnet latch in the upper radiator support panel and fit the M6x20 + Spring and Flat Washer through the hole and into the thread in the mounting bracket.

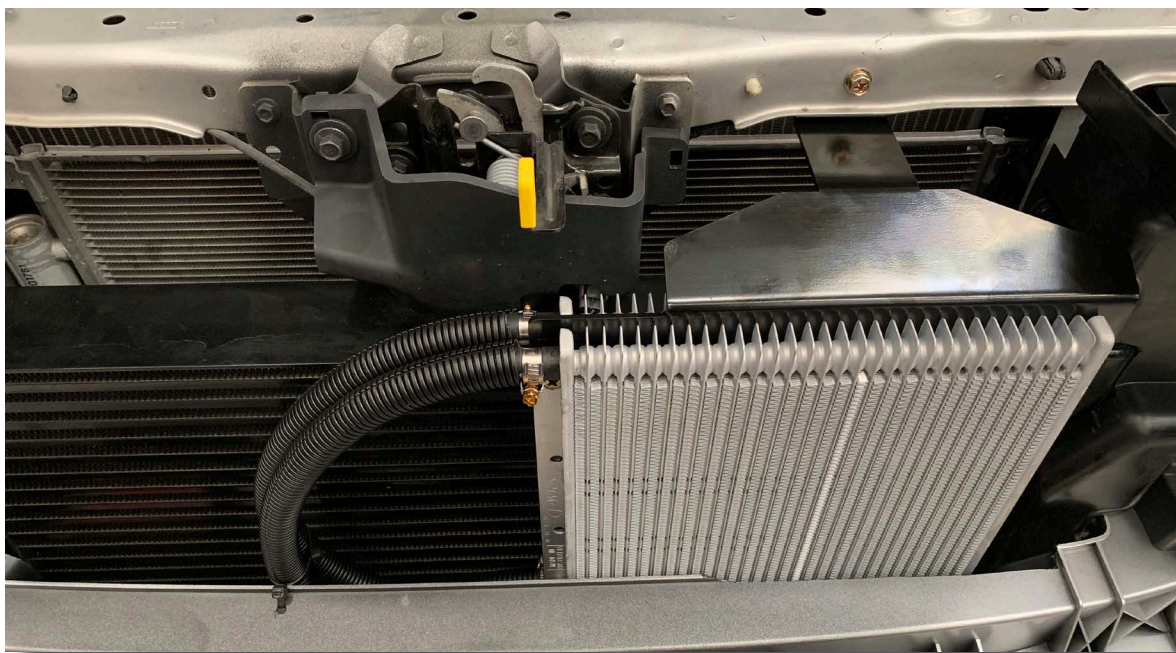

5. Some variants may have factory bumpers that will prevent the cooler from mounting all the way forward. There are also some variants that have grills that will hit the cooler when trying to refit the front grill into place. If you have one of these variants you have 2 options.

Option A: Use the optional top mounting bolt and spacer to move the top of the bracket away from the grill and bumper. This will provide sufficient clearance at the front of the cooler. If you have an aftermarket intercooler fitted, this may not work so we would recommend choosing Option B.

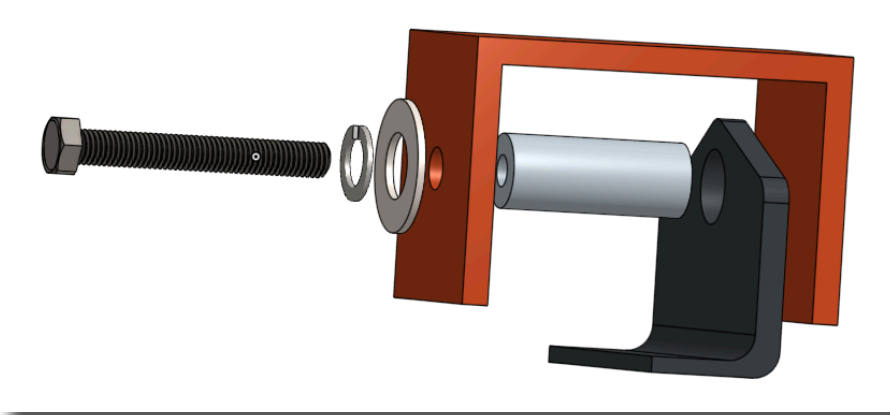

Option B: Trim the bumper and rear of grill to provide clearance to the cooler. Usually it only requires the small raised section at the back of the bumper (approx 5mm) to be trimmed and about 5mm of the rear of the grill to allow enough clearance for the cooler.

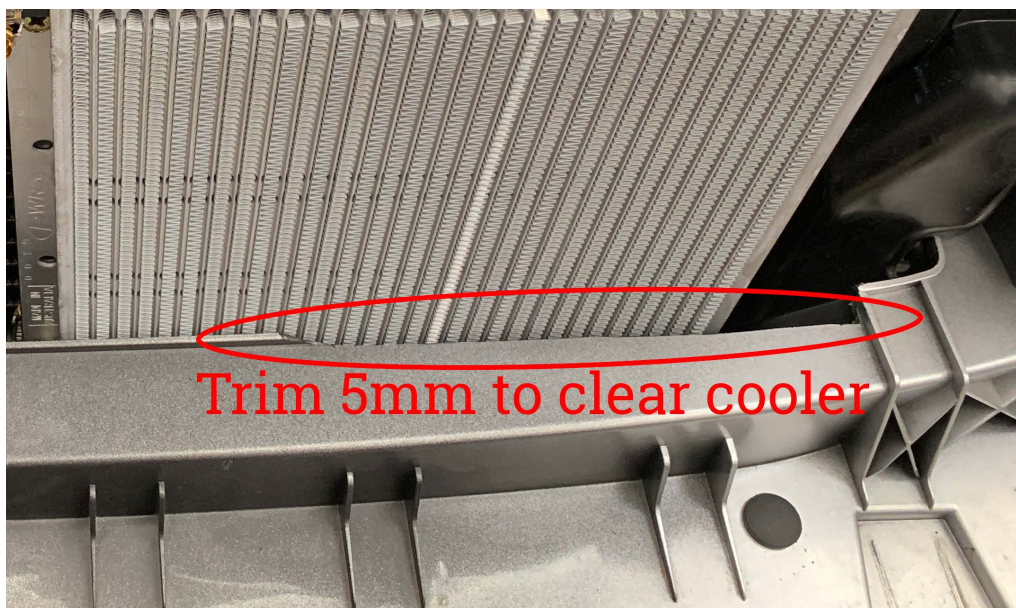

- From under the vehicle, secure the lower section of the bracket to the under side of the lower radiator support panel using the 2 x Metal Self Tapping screws. Before installing the screws, please make sure the cooler has clearance around it to prevent rubbing against any part of the car.



- Create a slack loom in the cooler lines and cable tie the lines to the lower radiator support panel to reduce strain on the cooler fittings.

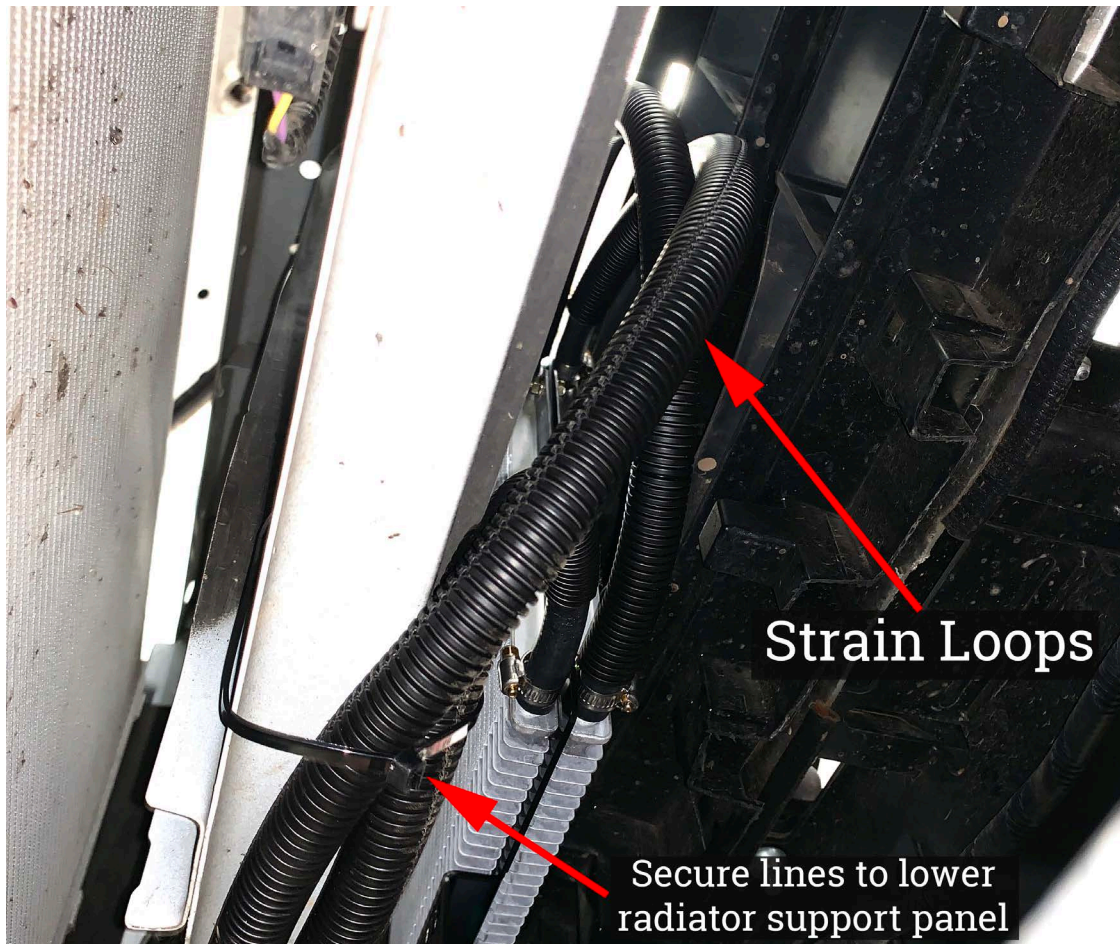

8. Feed the loop end of the lines through the gap directly above the chassis on the passenger side just behind the radiator support panel. Cable tie the cooler lines to the support panel along the way. Some vehicle variants may have an existing factory line running through this location - for those vehicles you will need to route the cooler lines under the radiator.



9. In the passenger side wheel arch, remove the rear rubber splash protector by removing the plastic screw clips and move protector out of the way.



10. Cable tie cooler lines firmly to the vehicle but not too firm that they cause flow restrictions and so that they are not too tight between tie points. Ensure the cooler lines do not prevent access to the engine oil filter by cable tying them to the air con lines above the engine oil filter.

The lines need to reach the area on the passenger side of the automatic, just above front prop shaft. (Do not cut the hose yet)

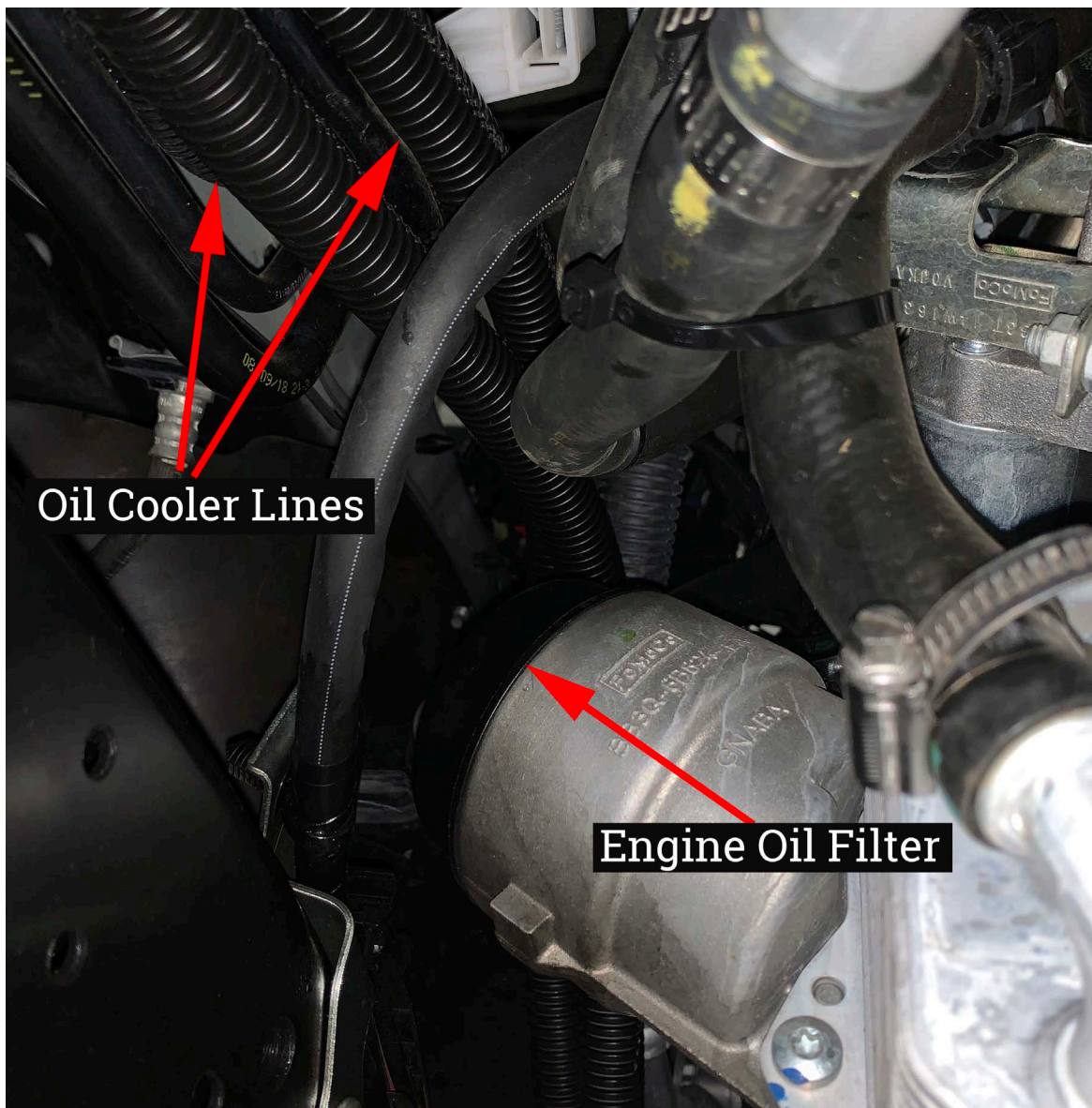

11. Using two hose clamps, clamp off the two coolant hoses that connect to the heat exchanger to prevent radiator fluid draining out.



12. Remove coolant hose clamps and then remove the hoses from the heat exchanger. Make sure you have a drain tin or bucket under the hoses to catch the small amount of radiator fluid that will drop out.

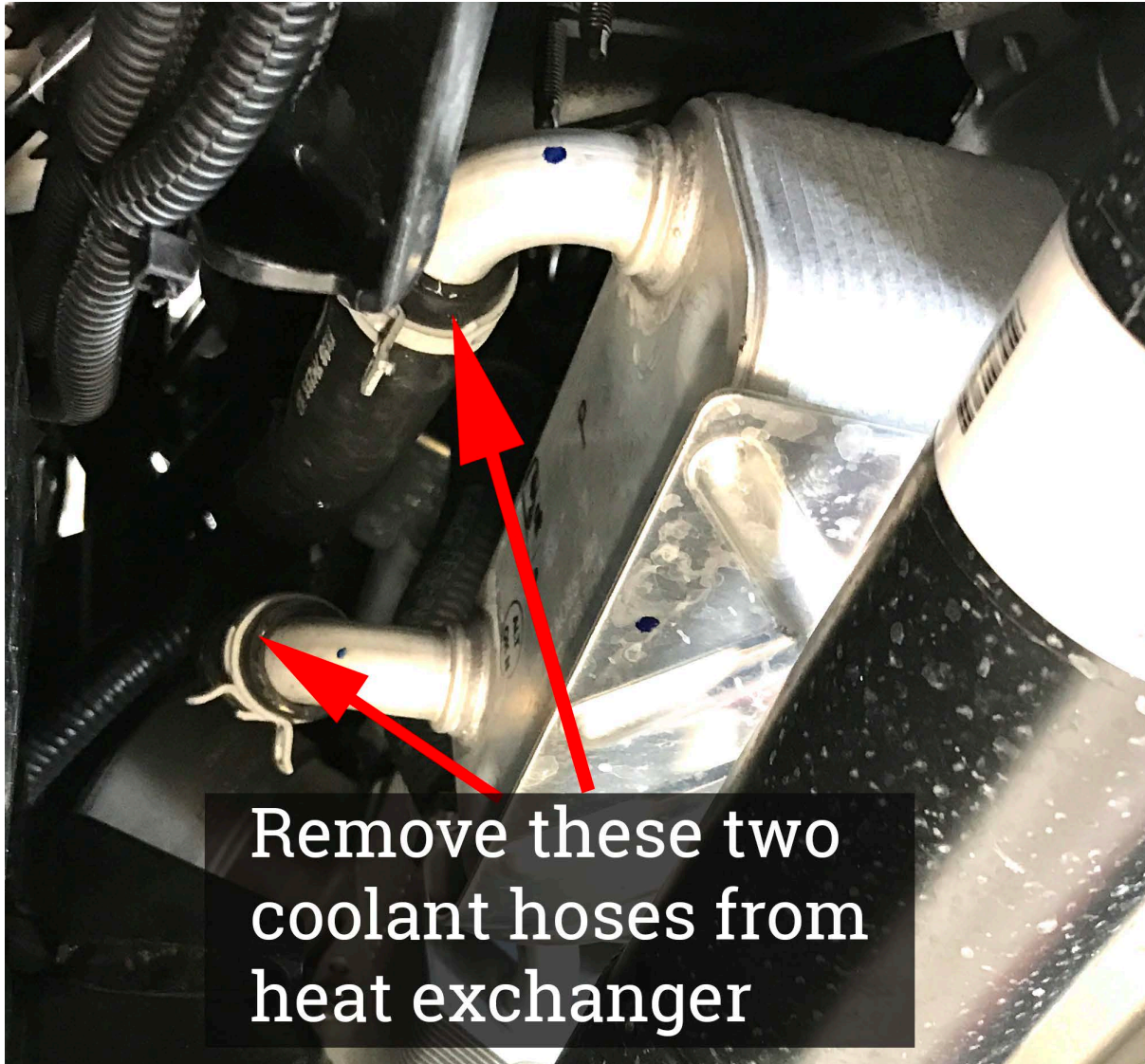

Ford and Mazda 6R80 6 Speed ONLY

Heat Exchanger Removal:

13. Remove the two split pins from the cooler union support bracket and unbolt the torx bit (10mm Bolt on early models) holding the bracket in place. Remove the support bracket but don't discard as we will reuse this bracket.



14. Unbolt heat exchanger by removing the three bolts holding it to the transmission. Two bolts are above the heat exchanger and one bolt below. All three bolts are either T40 Torx on newer models or 10mm hex head on older models. Do not discard the bolts.

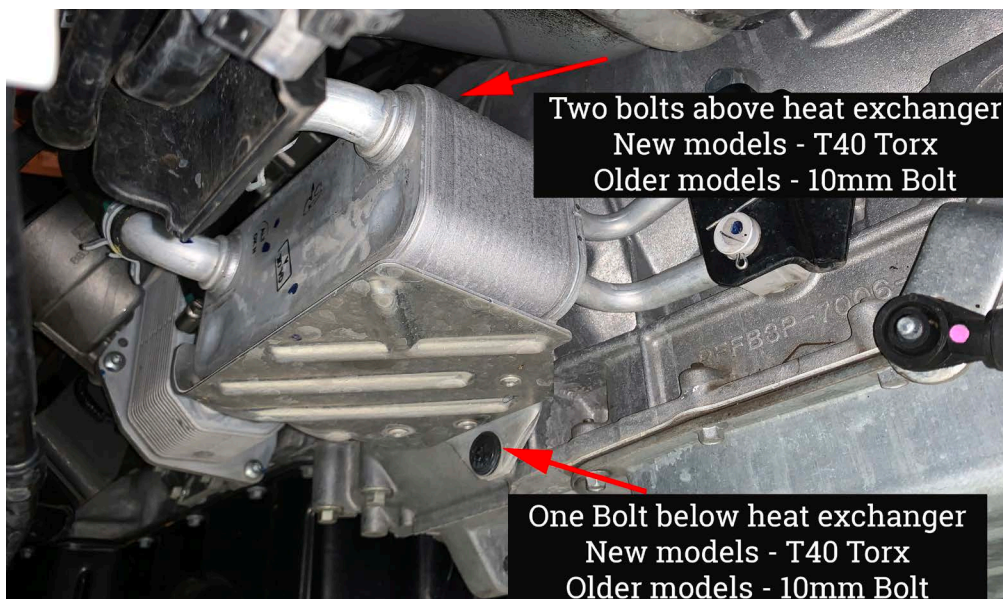

15. Remove the heat exchanger by gently removing the two union lines from the auto first, then the exchanger should be free from the auto. Have a drain tin or bucket underneath as some transmission fluid may come out. On 4WD models, it will require a bit of tetris to squeeze it down past the driveshaft but it does fit.
16. Check that both custom made unions have two (2) o-rings fitted prior to installing. Run a small covering of transmission fluid around both o-rings on both unions to provide lubrication.

Install the unions by carefully inserting them into the openings left by the heat exchanger. Secure the new unions with the factory support bracket previously removed and secure using one of the T40 torx bolts (or 10mm hex head bolts).

To prevent oil spilling, you can use the rubber covers from the Oil Cooler outlets temporarily until you are ready to fit the lines.

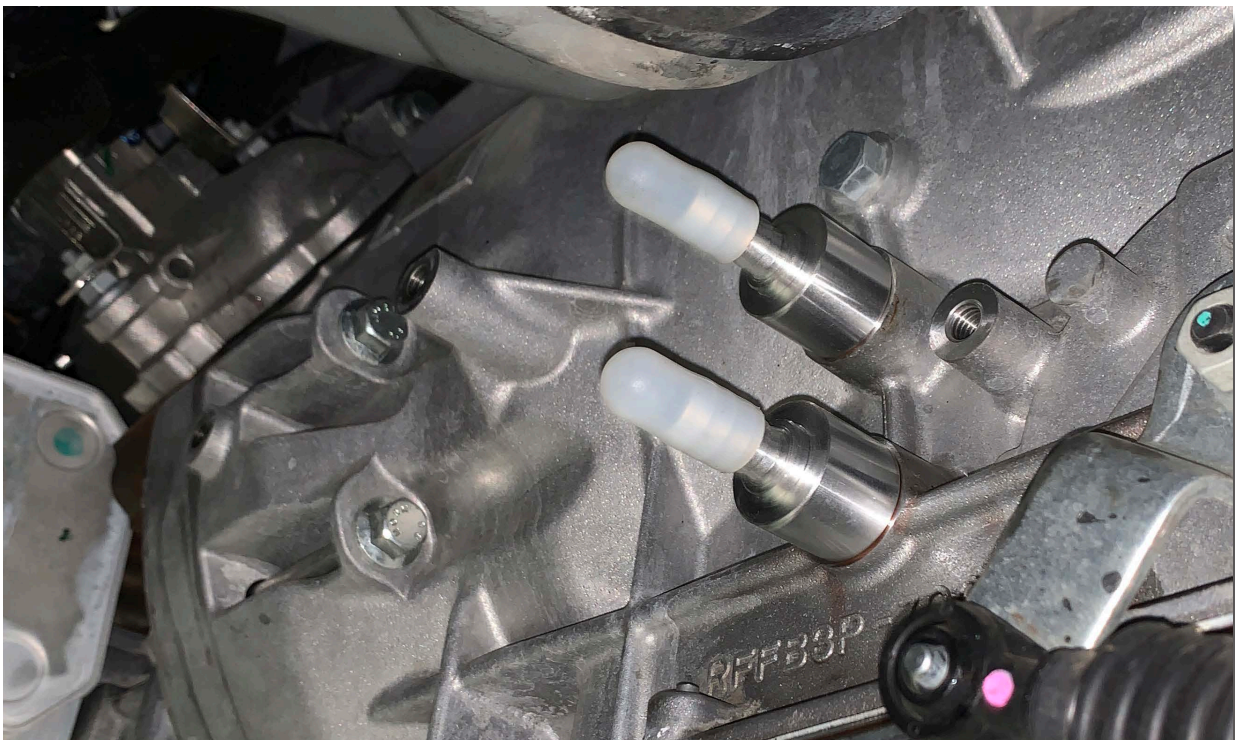

*Note: If installing with a transmission temperature gauge, the union to use for for the temperature sensor (Hot Line) is the lower union.

Ford 10R80 10 Speed ONLY

Heat Exchanger Removal:

17. Using a T40 torx bit, remove the three bolts holding the heat exchanger to the transmission. Don't discard the bolts.
The top two bolts are extremely difficult to access. If your tooling doesn't provide you access to these bolts, see next step.

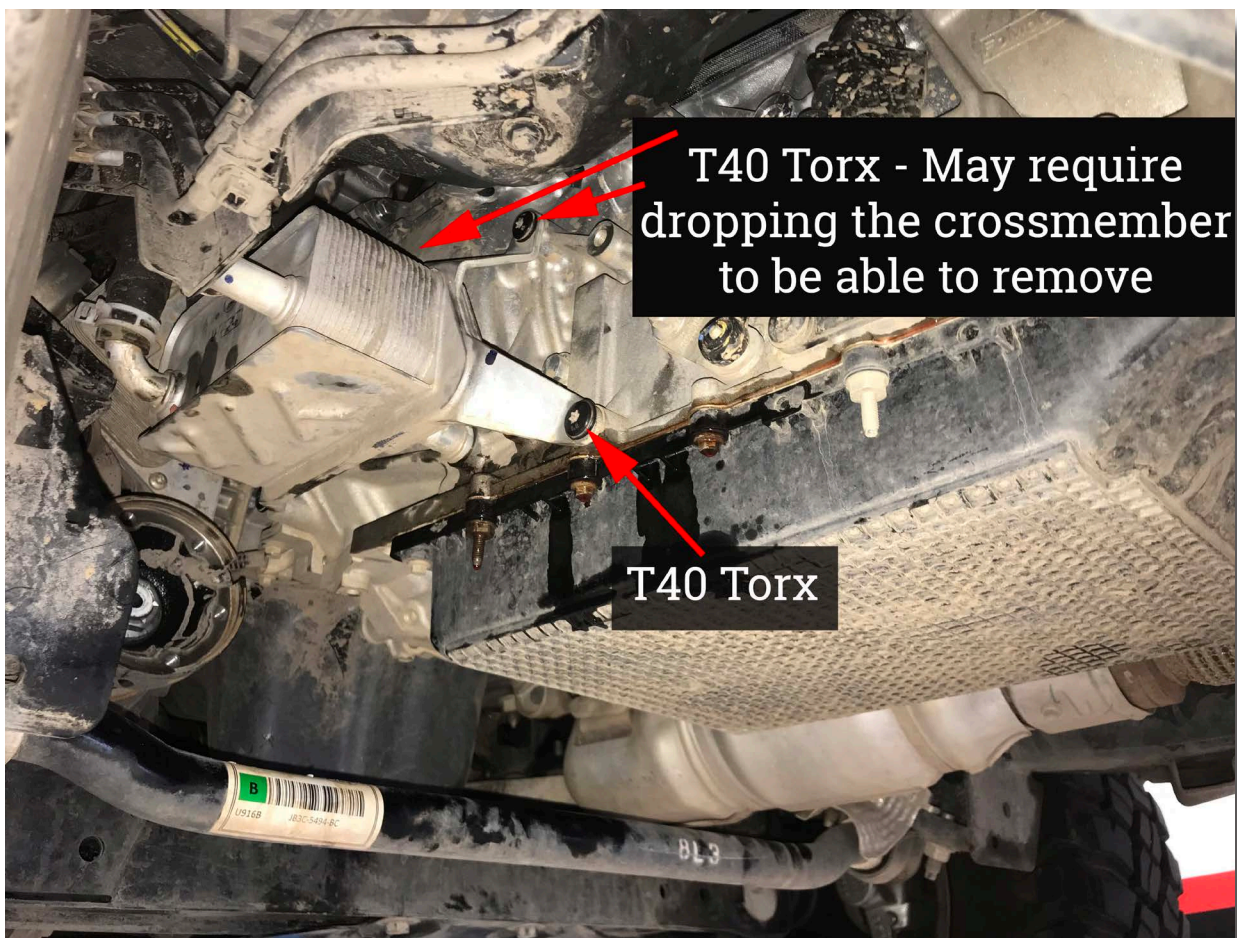

18. If you can't access the top torx bolts, you will need to lower the crossmember. First, you will need to support the transmission with a transmission jack or adjustable support before unbolting the crossmember.

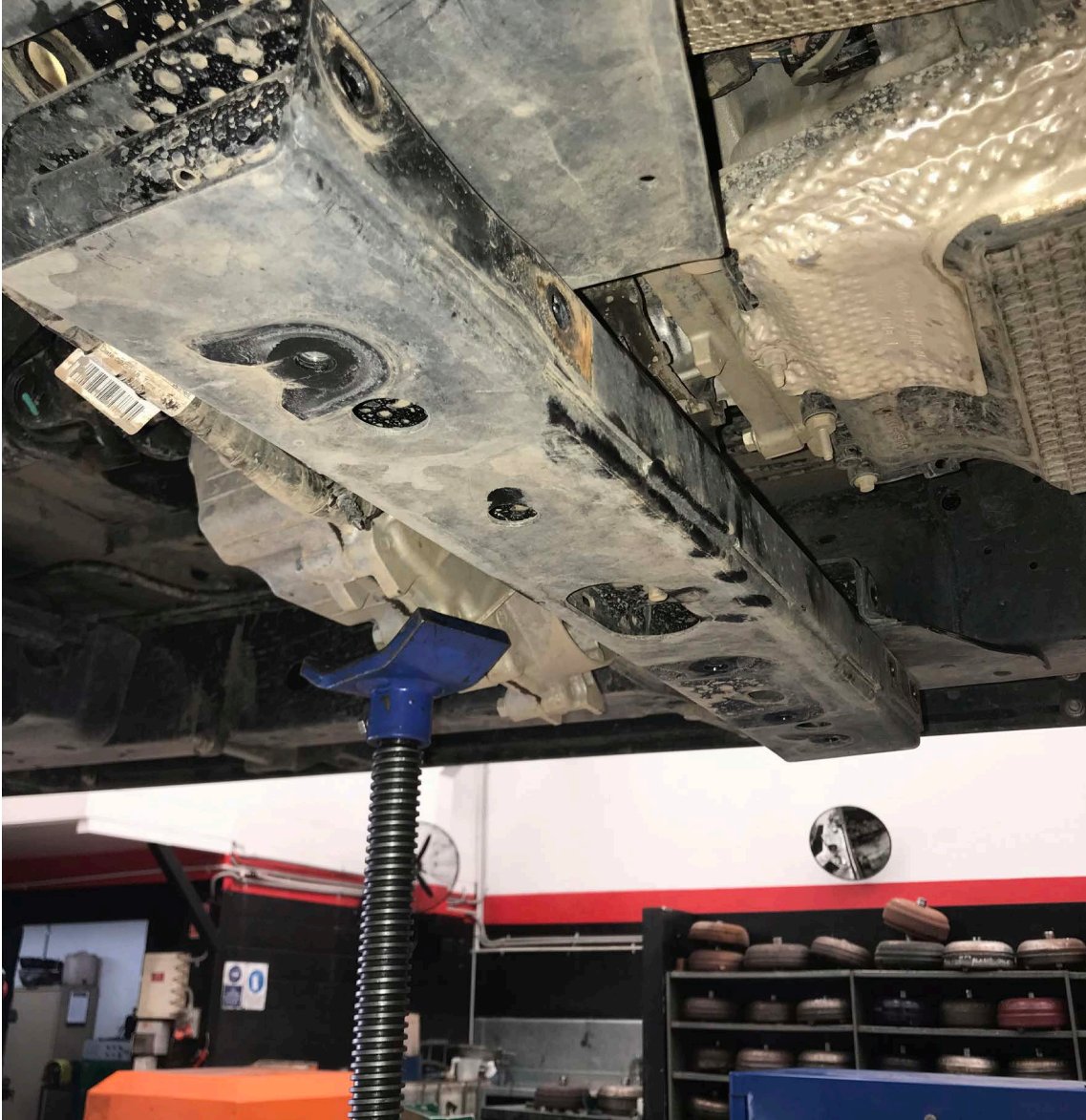

19. Start by unbolting the exhaust mounting on the drivers side above the crossmember and remove the nuts from the four (4) crossmember bolts.

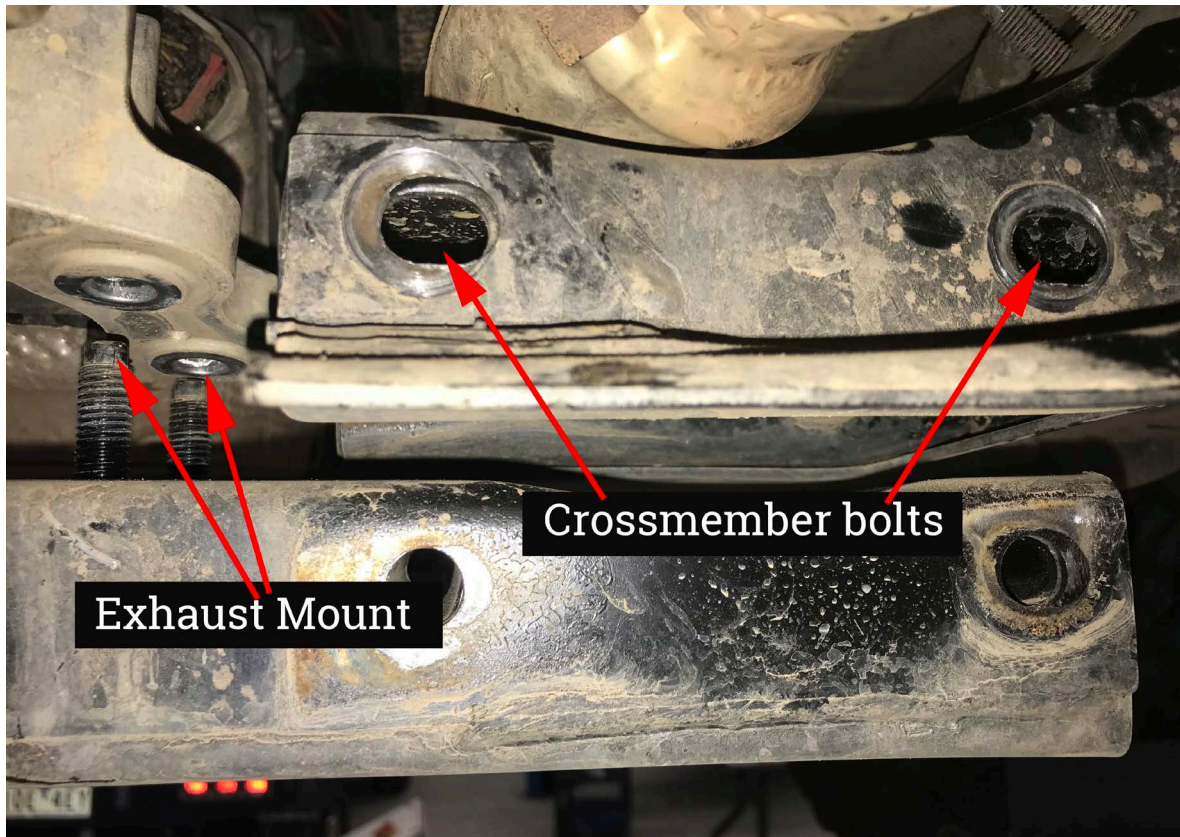

20. Take the weight of the transmission and crossmember on the transmission jack/support so that you can remove the crossmember bolts completely. Once the bolts are removed, slowly lower the transmission and crossmember down approx 50mm while monitoring any wiring or hoses that might get snagged.

21. With the transmission lowered, you will now be able to access the top two torx bolts on the heat exchanger. Don't discard the bolts.



22. Gently remove the heat exchanger from the transmission by pulling it horizontally away from the transmission. Have a drain tin or bucket underneath as some transmission fluid may come out.

23. Install the two supplied custom cooler unions. Check that both unions have two (2) o-rings fitted prior to installing. Run a small covering of transmission fluid around both o-rings on both unions to provide lubrication. Install the unions by carefully inserting them into the openings left by the heat exchanger. Secure the new unions with the supplied bracket using one of the T40 torx bolts removed previously.



*Note: If installing with a transmission temperature gauge, the union to use for the temperature sensor (Hot Line) is the rear union.

The remainder of the instructions applies to all transmissions.

24. Fit J-Pipe to coolant hoses and push in as far as possible. Test that you can easily manouvre the J-Pipe near one of the heat exchanger vacant bolt holes for sercuring the J-Pipe after fitment. Clamp the coolant hoses using the two (2) supplied large screw clamps.
25. Secure the J-Pipe to one of the heat exchanger vacant bolt holes using the previously remove T40 torx bolt (10mm hex head bolt).



26. Check the routing of the cooler lines prior to cutting to ensure they will not impact on any part of the vehicle or could become jammed or pinched. Cable tie them so they keep sufficient clearance around the Engine Oil Filter for ease of engine maintenance.
27. Measure where they need to be cut for the unions while allowing for some slack between the unions and the first cable tie point.

28. Cut rubber cooler lines to length and pull back the conduit. Slide the remaining small screw clamps onto the cooler hose and then insert the hoses onto the unions. Do not use any lubricant on the barbed fittings. Re-fit conduit into place, trim if necessary.

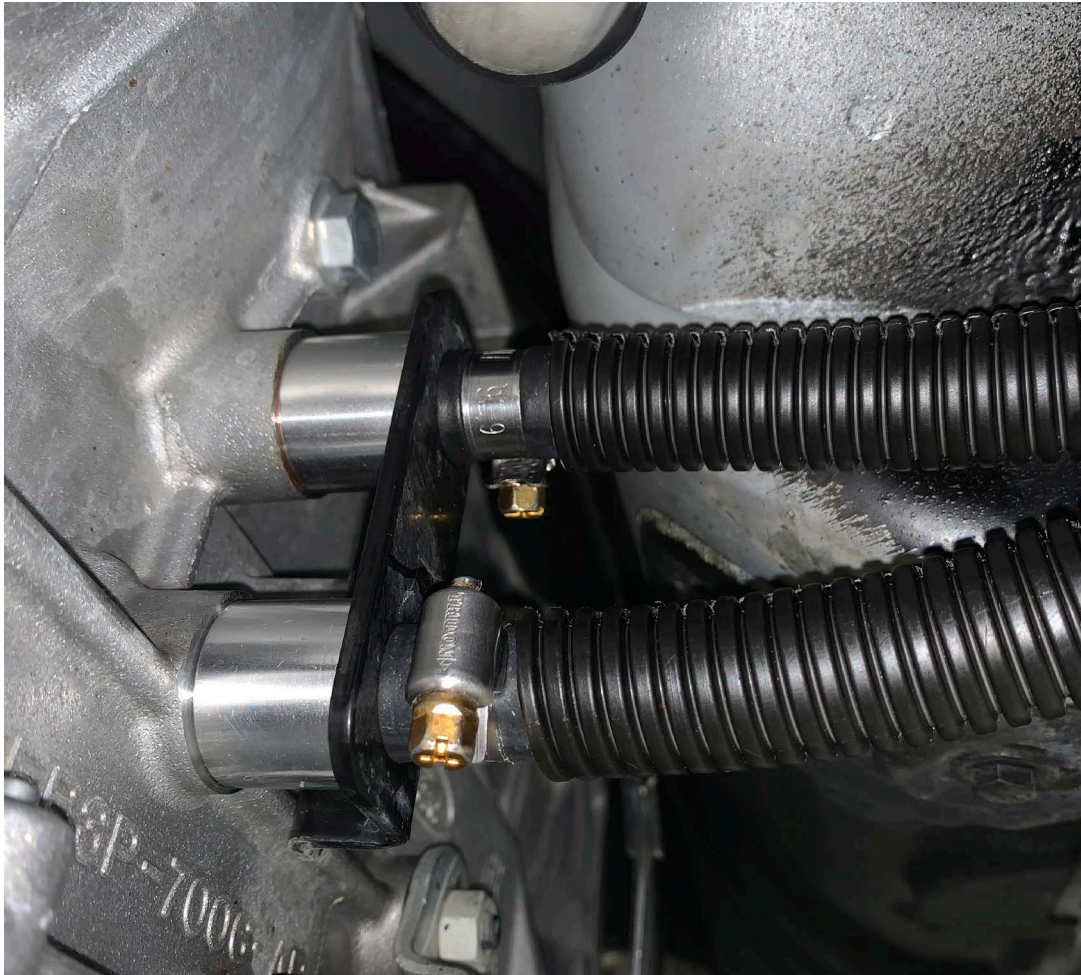

29. Check clearance of hoses to front prop shaft. Cable tie the coolant hoses to prevent rubbing.

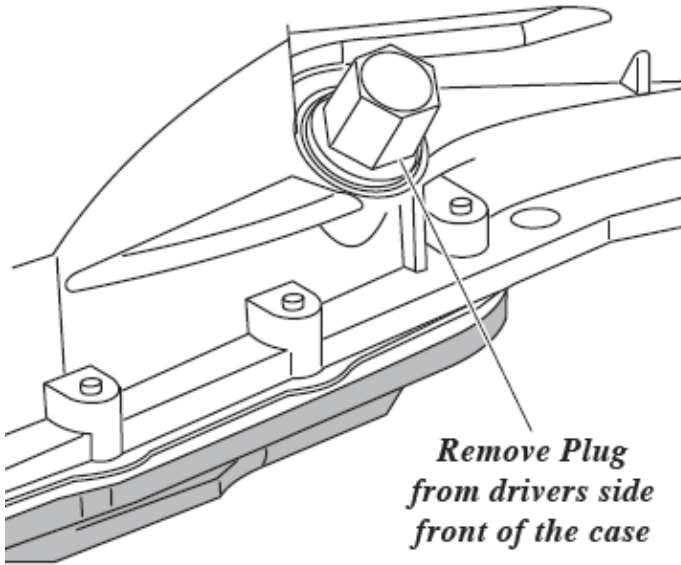

30. Recheck transmission coolers, fittings, hoses, unions, mountings and clamps for any leaking or loose fittings. Tighten if neccessary.
31. Check the transmission fluid level and if necessary, top up with Genuine Transmission Fluid or any full synthetic transmission fluid that meets or exceeds the genuine oil specification.
32. Check engine coolant level and top up with the manufacturers recommended coolant.
33. Clean any spilt engine coolant or transmission fluid from under the vehicle so that it is easy to detect a leak. You can use brake cleaner as it will evaporate quickly. Avoid spraying exhaust and body work with brake cleaner or solvent.
34. Road test vehicle for a minimum of 15 minutes. Try to find a couple of hills that will get the transmission to work hard.
35. Check the transmission coolers, fittings, hoses, unions, mountings and clamps for any leaking or loose fittings. Tighten if neccessary.
36. Check engine coolant level and transmission fluid level again.
37. If step 34 required tightening of any part or if Step 35 resulted in coolant or transmission fluid showing low, repeat steps 31 to 35
38. Refit any bash plates, front grills, aftermarket accessories that were removed during the fitment of the cooler kit.

FLUID FILL PLUG

**The recommended
transmission fluid for
the Ford 6R80 6 Speed
is Mercon LV[©]**

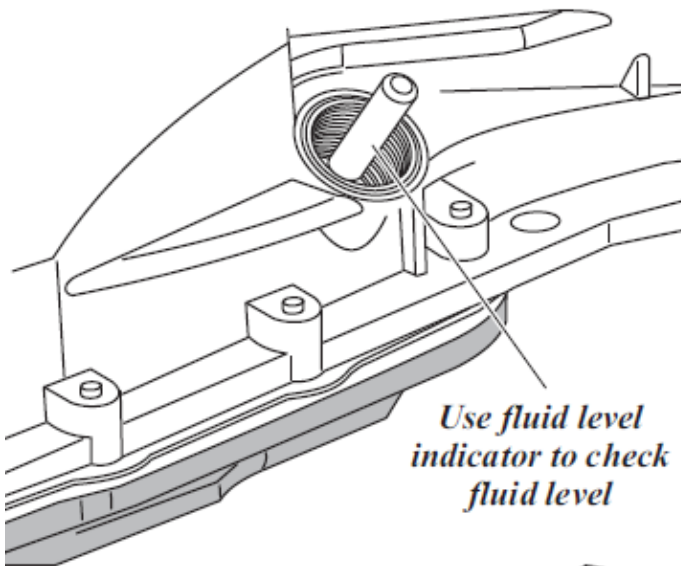
FLUID LEVEL INDICATOR

**The recommended
transmission fluid for
Ford 10R80 10 Speed
is Mercon ULV[©]**

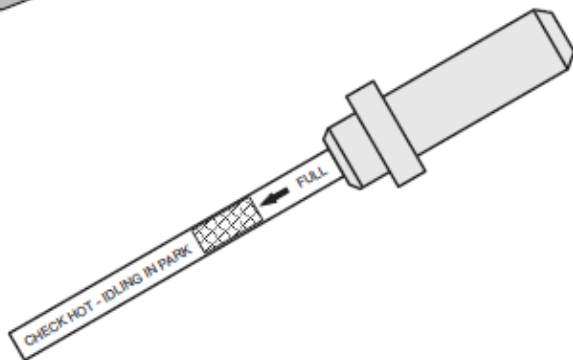

**Check fluid level hot idle in park
80° - 85°C (175° - 185°F)**

This completes the installation of the Dual External Transmission Oil Cooler Kit: Ford Ranger PX/Mazda BT50 6 Speed and Ford Ranger PX 10 Speed

Please remember ALL automatic transmissions have a service interval of
2 years or 40,000km to improve the longevity of the transmission.