



Dual External Transmission Oil Cooler Kit Suitable for:



**Isuzu D-MAX (Aug 2020 onwards)
Mazda BT50 (Aug 2020 onwards)
with 6 Speed AC60 Automatic
Transmission**

**WITH THE FOLLOWING ENGINES:
4JJ3-TCX 3.0L TURBO DIESEL - Aug 2020 TO PRESENT**

Please read through all of the instructions carefully before proceeding. If any of the information does not appear correct or the diagrams don't match your vehicle, please contact Wholesale Automatic Transmissions on +61 3 9762 8004.

Parts List

Dual Cross Flow Oil Coolers Pre-Mounted to Bracket

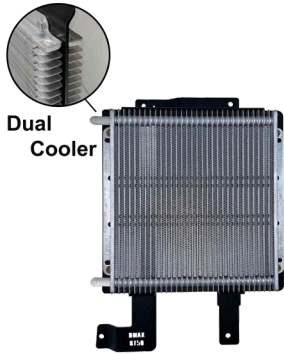

1 x M8x20 SEMS Bolt For Mounting Bracket



6 x 8-16mm Stainless Steel Screw Clamps



1 x M6x16 SEMS Bolt and M6 Flange Nut

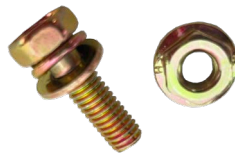

5m x 10mm High Temp Cooler Line Hose with Conduit



10 x 300mm Cable Ties



1 x Dual Cooler Link Hose and Conduit



Expected Installation Time: 2 Hours

Summary of Installation - For Experienced Fitters

- Ensure you have enough transmission oil to top up your transmission.
- Remove two(2) clips holding intake scoop and ten(10) clips holding the radiator apron.
- D-MAX: Remove radiator apron. Then remove the three(3) clips and the one(1) screw, through the badge, holding the upper grille in place. Remove upper grille.
- BT50: Remove three(3) hidden clips under the front of the apron and also the one(1) screw in the middle of the badge.
- BT50: Remove four(4) clips and one(1) screw from each wheel arch holding front bumper.
- BT50: Remove one(1) clips and one(1) screw holding each sides lower section of bumper.
- BT50: Gently pull forward on bumper to partially remove - careful of wiring connector on passenger side that must be disconnected prior to full removal of bumper.
- Unbolt passenger horn and set aside. Unbolt lower centre support. Keep both bolts.
- Connect Dual cooler link hose to coolers - front lower to rear upper connections. Secure with supplied hose clamps. Connect long loop to remaining connections. Do not cut yet.
- Lower bracket into place and secure top of bracket using OEM horn bolt and mount.
- Secure bottom of bracket to centre support using OEM bolt and supplied M8 SEMS bolt.
- Mount horn to top of cooler bracket using supplied M6 SEMS bolt and flange nut.
- Route cooler hose in a sweeping U shape to run along the lower radiator support to the passenger side chassis rail and fit hoses through opening above chassis rail.
- Remove OEM hose connecting steel line and centre connection on heat exchanger.
- Route hoses along chassis rail until near wheel arch. Separate hoses. One will run across to transmission and along existing steel line then down behind existing hoses just behind bell housing to meet up with centre hose connection on heat exchanger.
- Route other hose further along chassis rail/OEM wiring until you reach slip yoke on front shaft. Route across the top of existing lines to then connect to steel line on side of transmission. Secure all lines with supplied hose clamps.
- Refit bumper, grille and radiator apron by reversing earlier steps
- Check transmission fluid level with engine running and removing the 'Check' bolt in pan.
- If no fluid coming from 'Check' bolt, remove the 24mm bolt on the transmission extension housing. Top up transmission with OEM or equivalent transmission fluid.
- Replace all bolts. Clean up any transmission fluid. Then Road test vehicle.
- On return, recheck transmission fluid again and also check for leaks and retighten any fittings as required. Refit and bash plates or parts by reversing earlier steps.

Detailed Installation Instructions

Before Commencing work, please ensure that you have sufficient transmission fluid to top up the transmission at the end of the job.

While the minimum we recommend to have available is 1 litre, we do not provide an exact amount as we always recommend ensuring the transmission is at the correct level - whatever the amount of fluid required to achieve this.

The top of the page will indicate if that page applies to Isuzu D-Max only, Mazda BT50 only or to All vehicles.

Ensure the car is fully switched off. It is also recommended that the vehicle is allowed to cool down prior to installation to avoid injury from hot transmission fluid.

This Page applies to All Vehicles

1. Open bonnet.
2. For both D-Max and BT50 - Remove Air Intake scoop on Drivers side by removing the two clips holding the air intake to the top radiator support panel. Set aside.

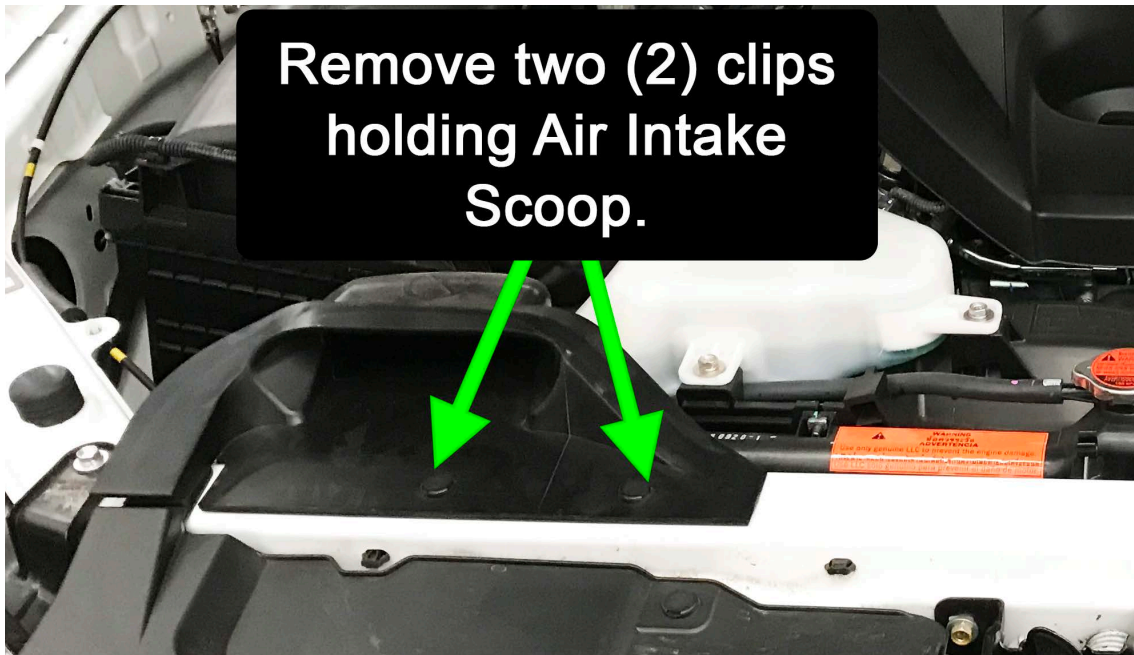

3. For both D-Max and BT50 - Remove ten (10) plastic clips from the top of the radiator apron and remove apron. Set aside.

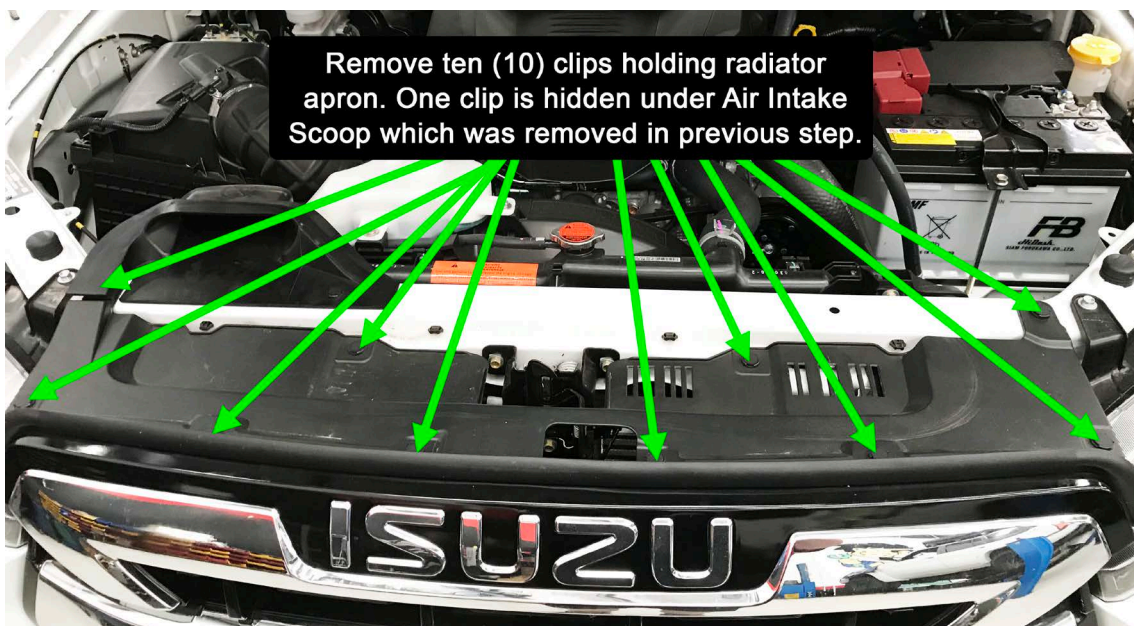

This Page applies to Isuzu D-MAX Only

4. After removing apron, remove the three (3) clips holding the upper grille. These won't be visible until the apron is removed.

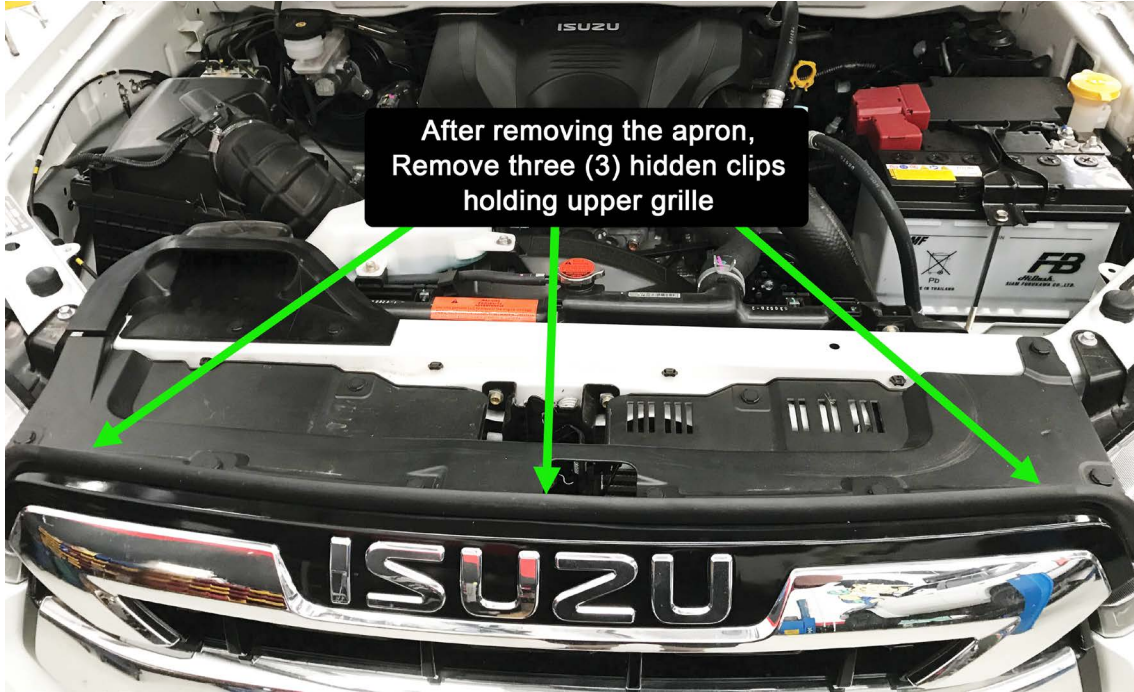

5. Remove the (1) phillips head screw in the centre of the grill located just under the Isuzu front badge.



6. Remove top half of the grill by firmly pulling forwards. Set aside.

This Page applies to Mazda BT50 Only

7. In the Mazda BT50 variant, the apron, grille and bumper need to be removed together to provide access while fitting the cooler kit. Locate and remove the three (3) hidden clips under the apron.

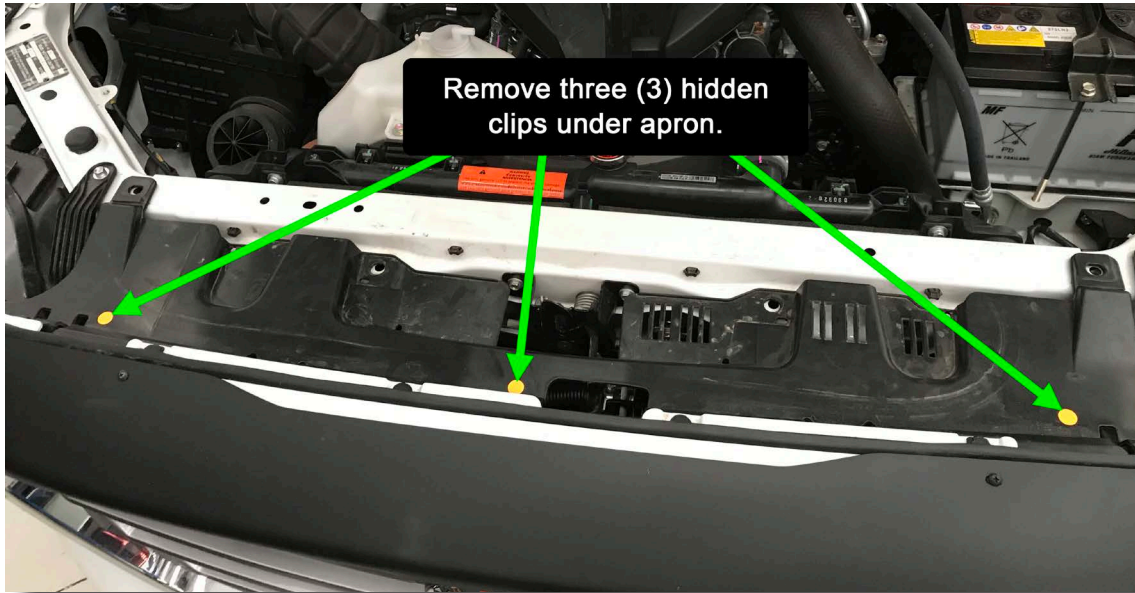

8. Remove the (1) phillips head screw in the centre of the Mazda badge located in the grille.

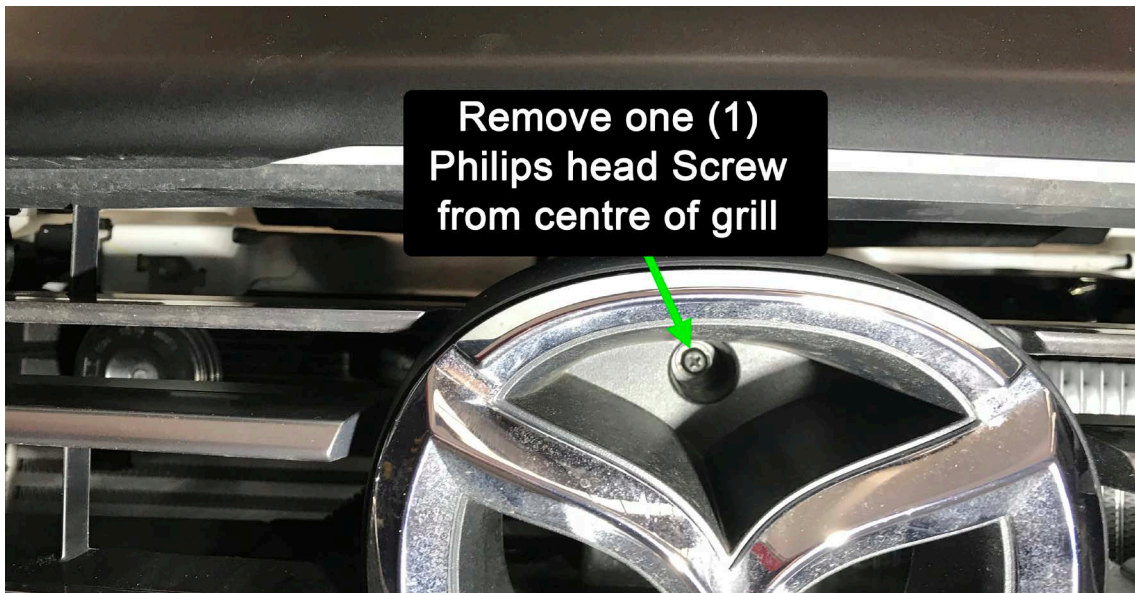

9. Remove the clips located on either side of the Mazda badge through the slots in the grille.

This Page applies to Mazda BT50 Only

10. Moving to the front wheel arches, remove the four (4) clips from the outer edge of the wheel arch holding the front bumper. Also remove the screw at the bottom of the wheel arch. Repeat for both sides.

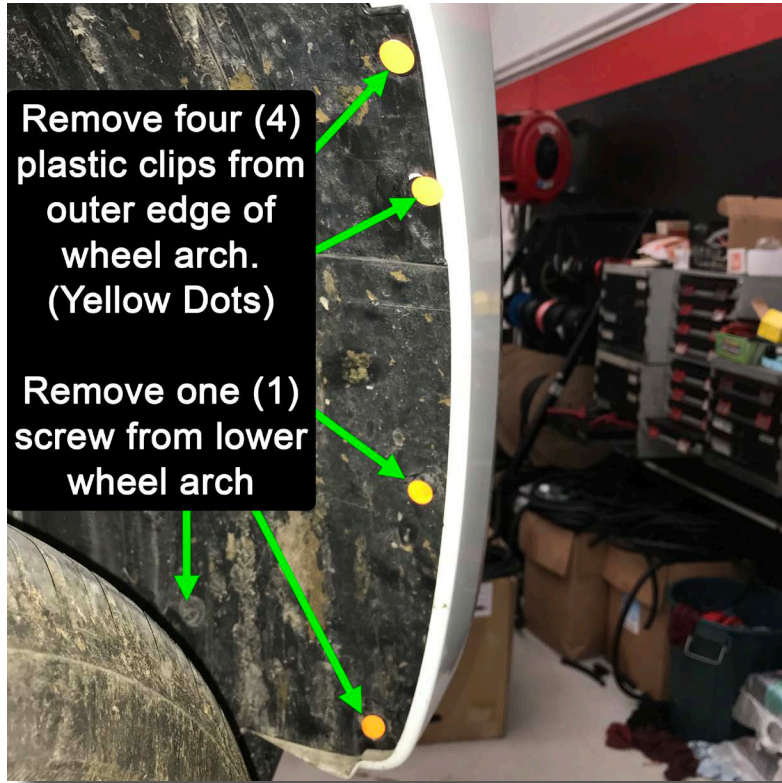

11. Remove one (1) nut from recess in front bumper skirt on both sides. While visible from wheel arch, easier to access from under bumper skirt with long socket extension.



This Page applies to Mazda BT50 Only

12. Remove one (1) clip from front bumper skirt.

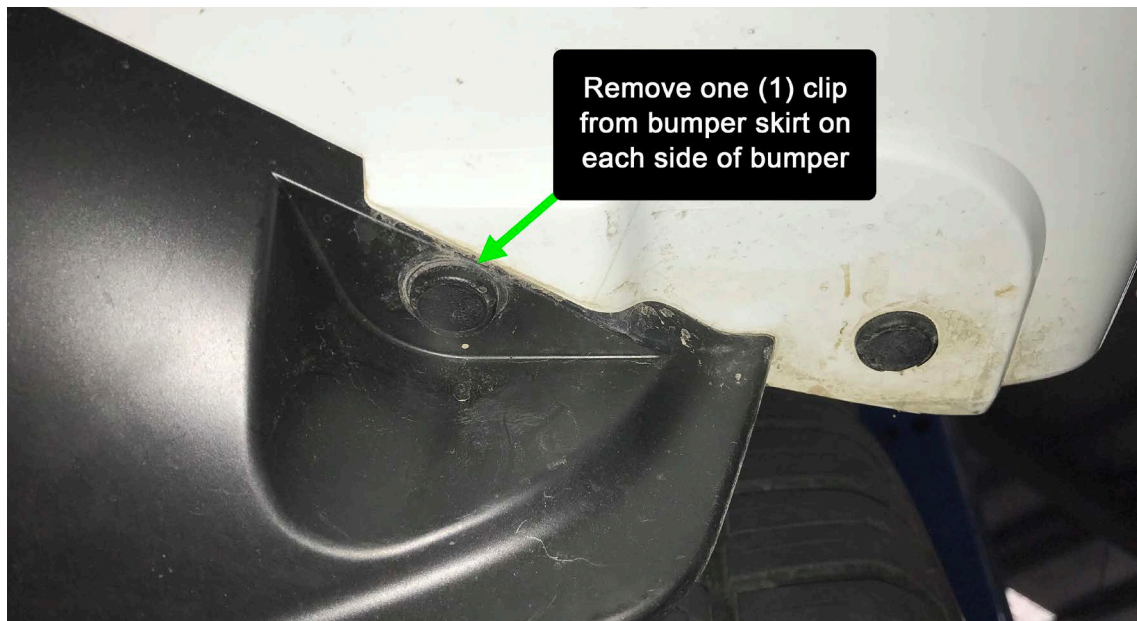

13. Gently pull forward on each side edge of the bumper to release.

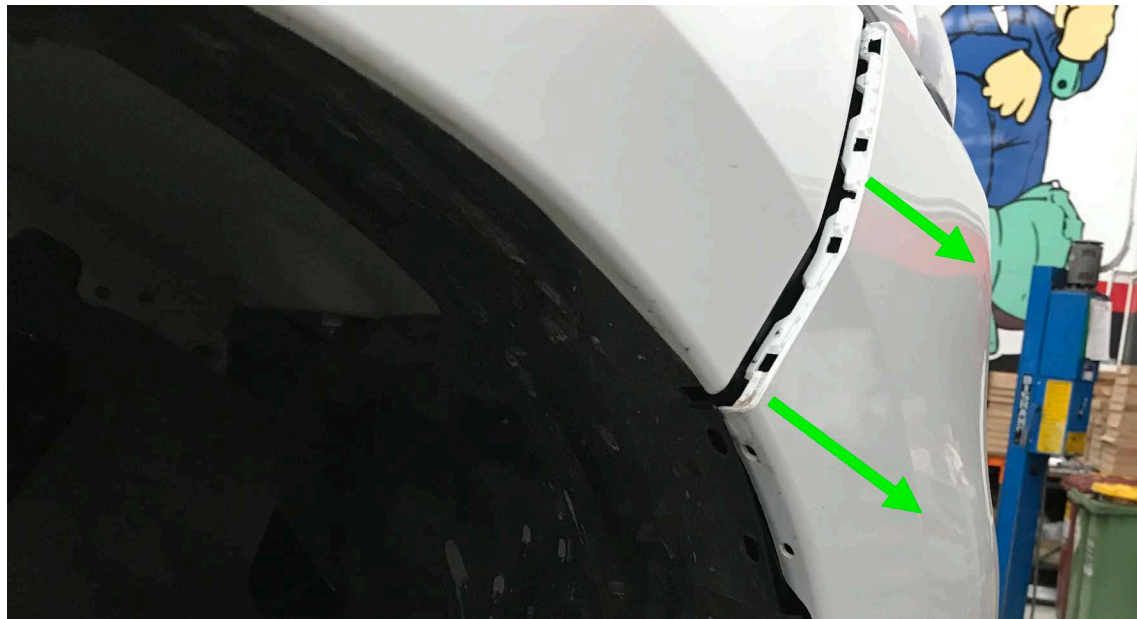

14. Before completely removing the bumper, disconnect the bumper wiring harness from the passenger side of the bumper, below the headlight. You may need to partly remove the bumper to access the connection.
15. Remove bumper, grille and apron assembly from vehicle. Set aside.

This Page applies to All Vehicles

16. Remove passenger side horn from radiator support panel and set aside. This will be mounted to the new cooler bracket. Do not discard bolt. You may also need to loosen/untape the wiring loom for the horn and temp sensor to provide enough slack for relocation.

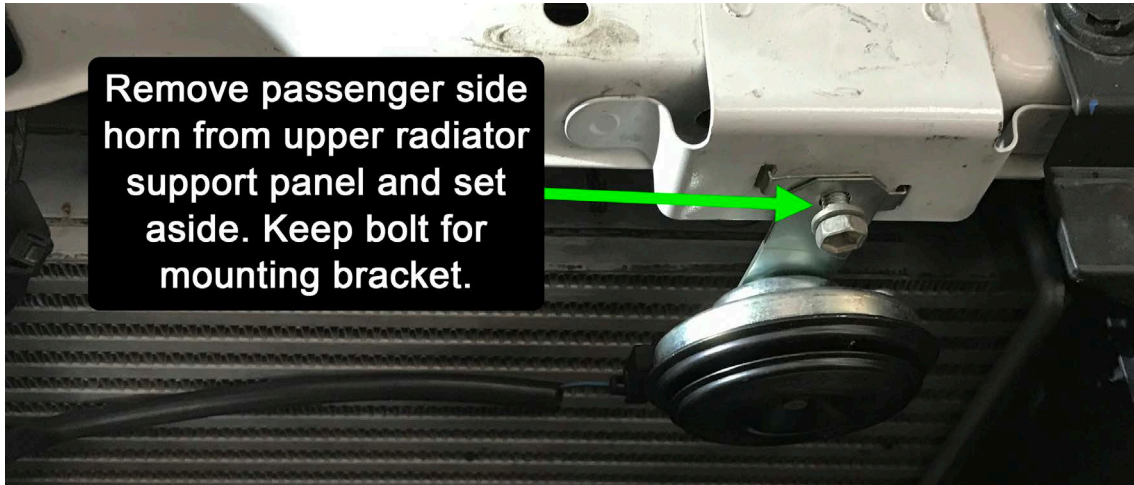

17. Place the cooler assembly on a clean flat surface to be able to fit the hoses. First fit the dual cooler link hose between the rear cooler onto the top connection and the front cooler onto the bottom connection. Fit each end of the long length of cooler line hose to the remaining connections on the front and rear coolers. **DON'T CUT THE LOOP YET.** Secure all connections with supplied screw clamps.

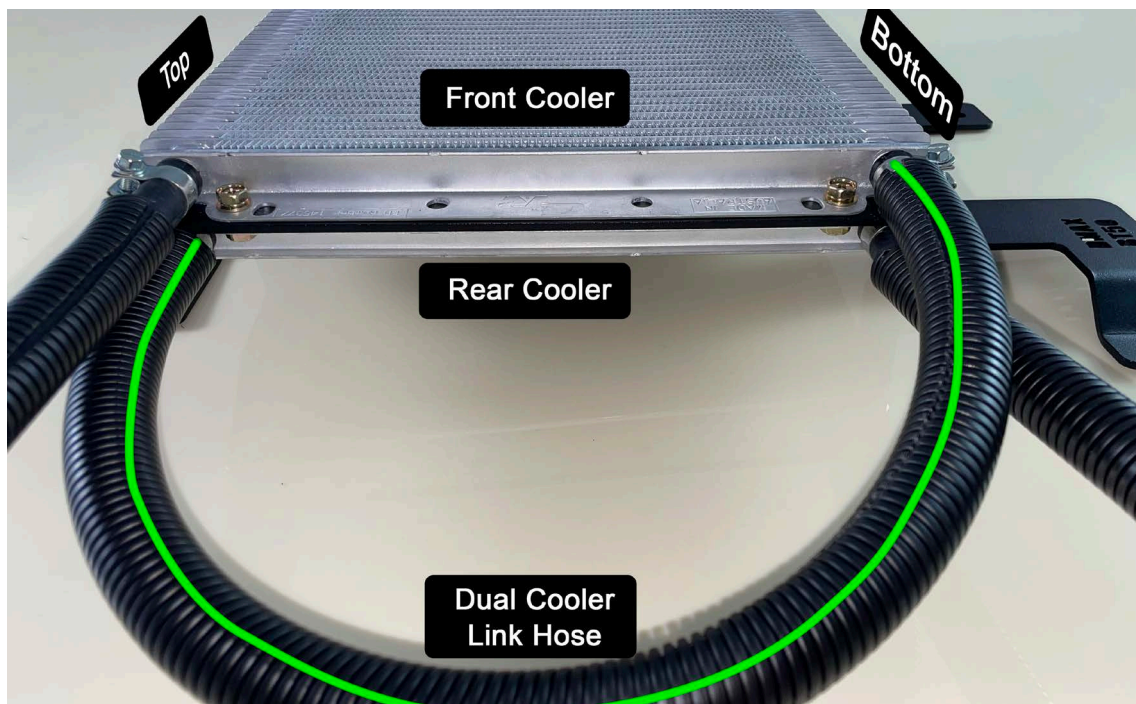

This Page applies to All Vehicles

18. Lower cooler assembly into location on passenger side of radiator with the cooler lines facing the drivers side of the vehicle.

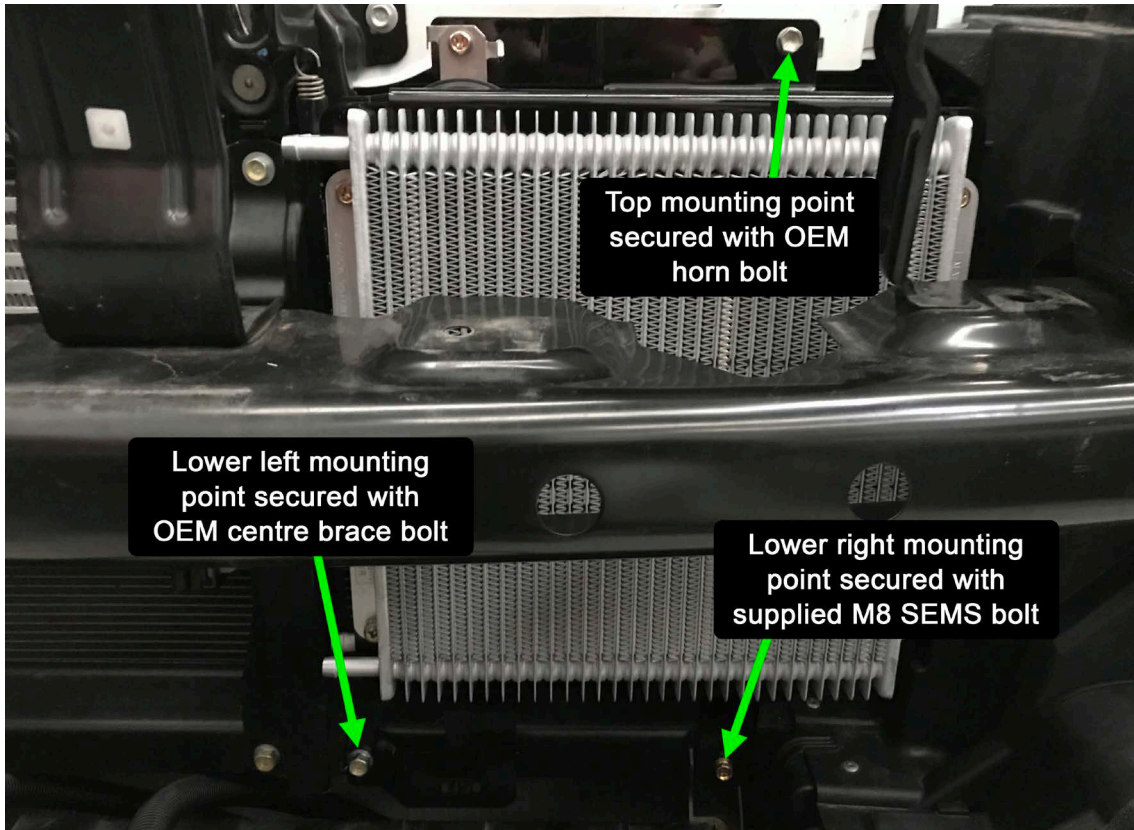

19. Remount the OEM horn to the top left leg of the cooler bracket.

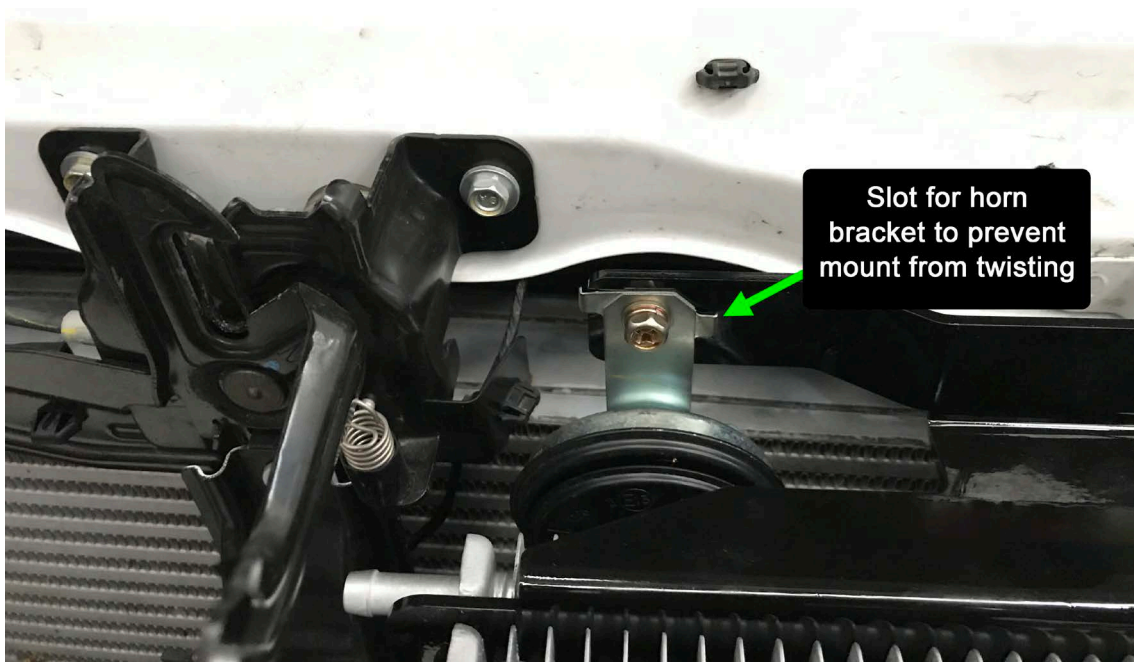

This Page applies to All Vehicles

20. Feed the long length of hose from the top connection in a U shape so that it drops to the lower radiator support panel and follows along the lower panel to end up back on the passenger side. Route the lower long length of hose into a U shape also to meet up with the top hose. Cable tie together. Both hoses will run across the lower panel, drop below the plastic guard and will exit around the passenger side of the radiator - just above the chassis rail.

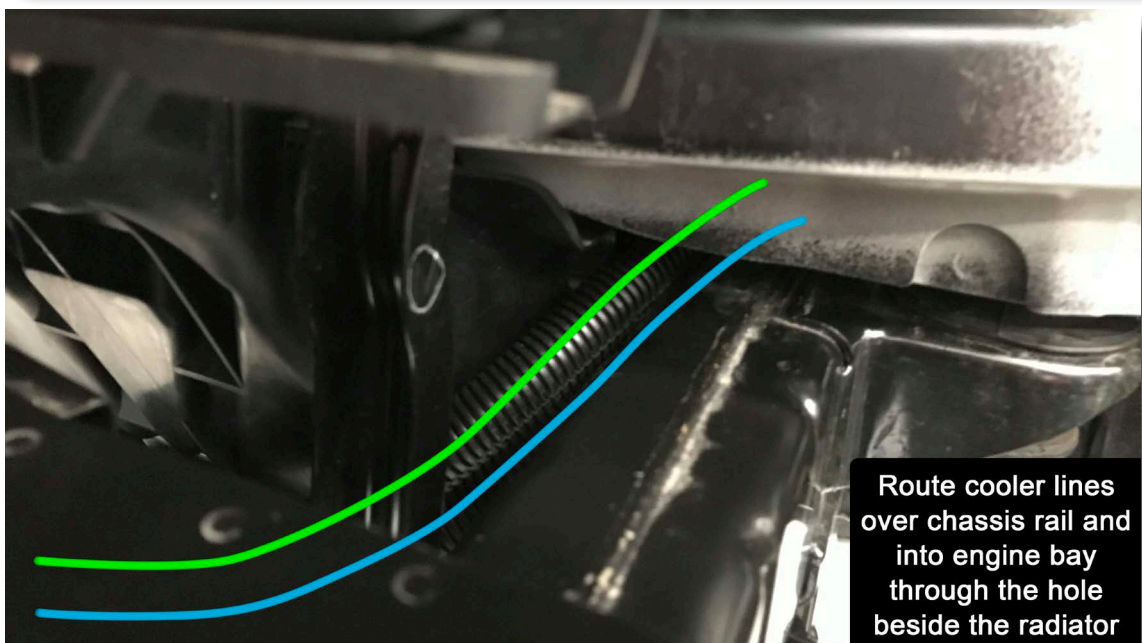
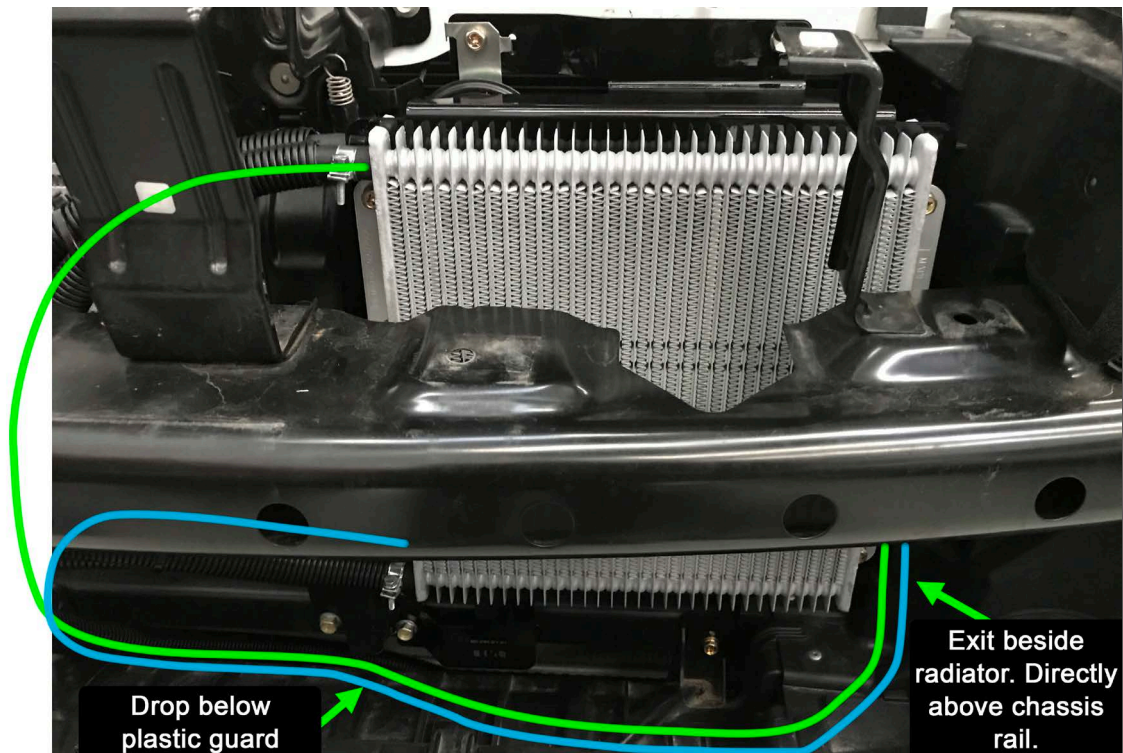

This Page applies to All Vehicles

21. Feed lines along the chassis rail until you reach the wheel arch. From wheel arch, route one of the cooler lines across to the side of the transmission and cable tie to the factory steel lines.

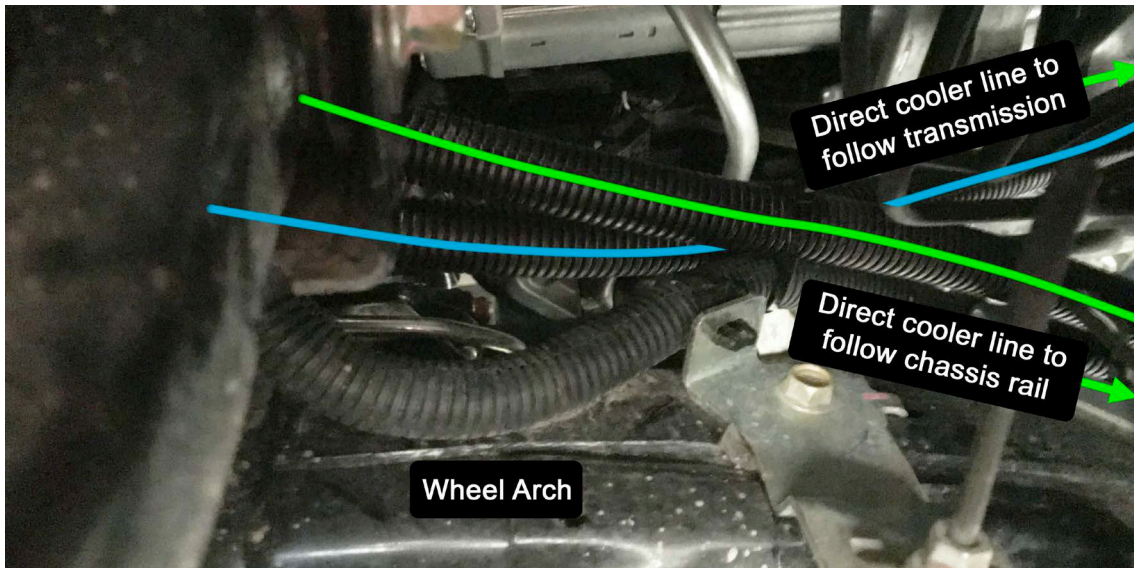

22. Remove OEM hose that joins the steel line on side of transmission with centre outlet in heat exchanger. This can be discarded.

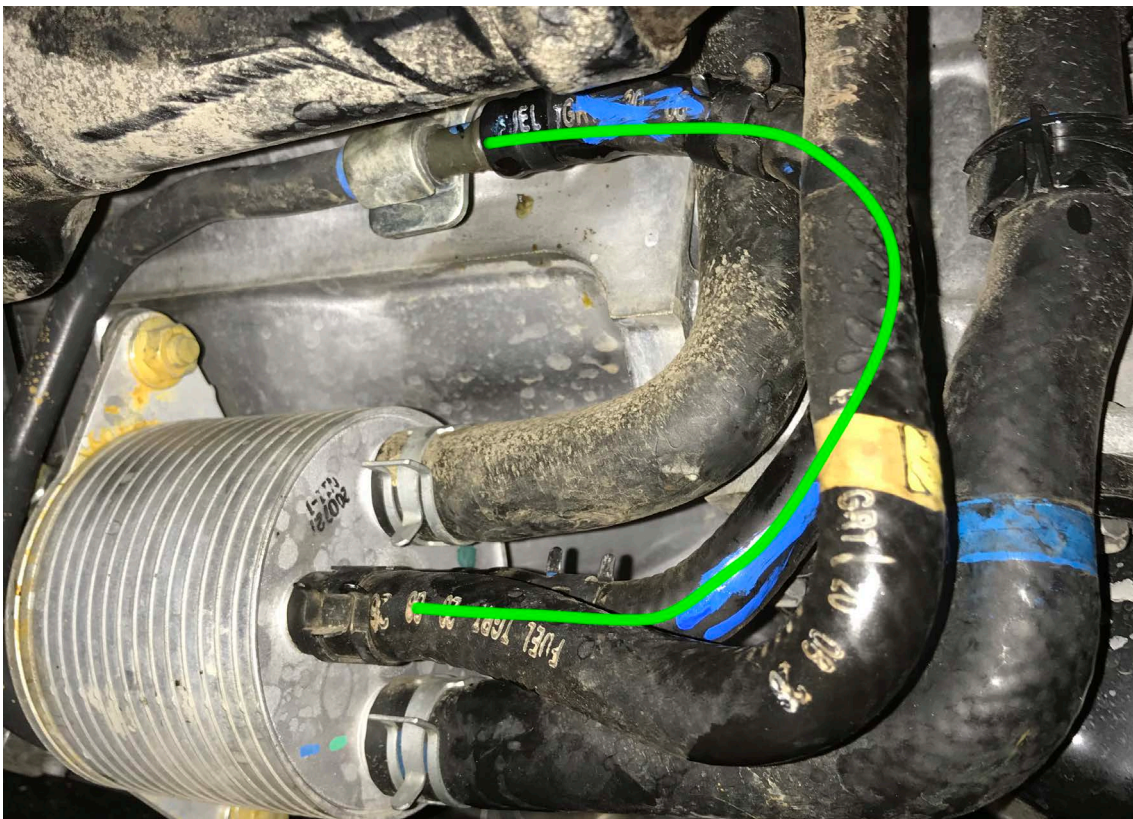

This Page applies to All Vehicles

23. The cooler line must run along the side of the transmission, hugging the transmission as to avoid the drive shaft.



24. Run the cooler line down beside transmission and existing cooler lines and connect to centre outlet on OEM heat exchanger. Secure with supplied screw clamp.

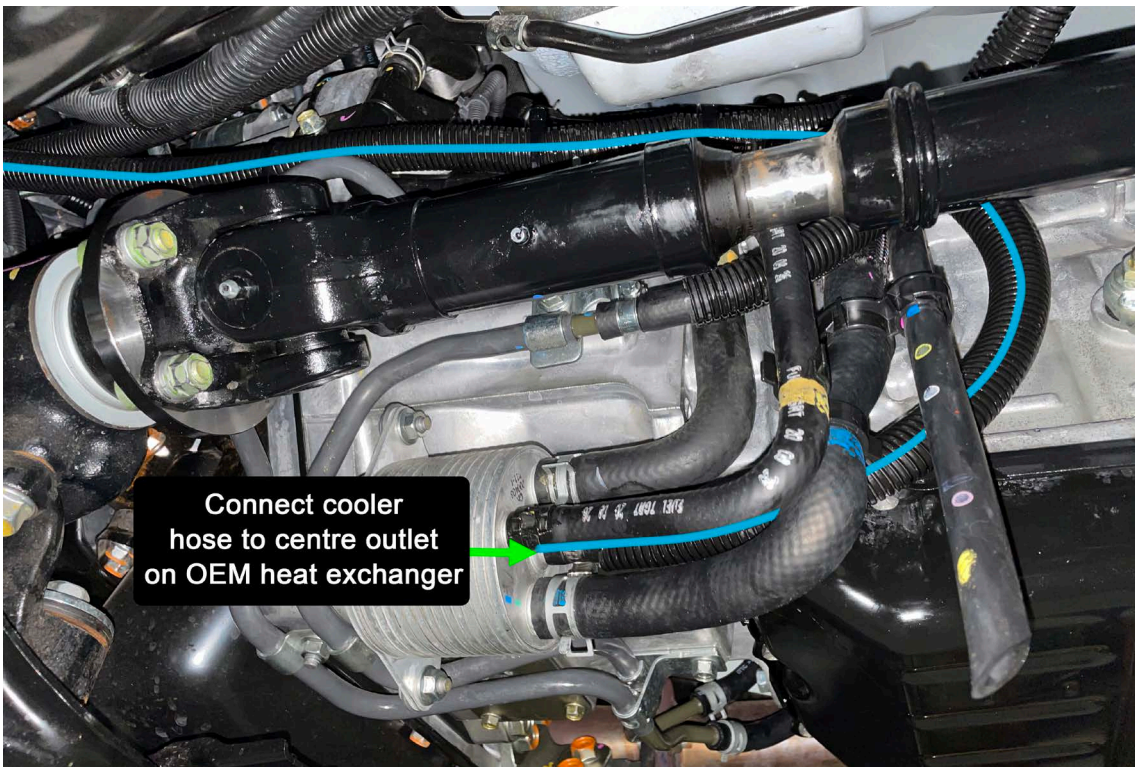

This Page applies to All Vehicles

25. Cable tie cooler line to ensure it does not come into contact with driveshaft.
26. Route the second cooler line further along the chassis rail - cable tied to the factory loom until you reach the the slip yoke of the front drive shaft.
27. Route the cooler line in a sweeping U shape above all existing lines and over to the transmission to meet with the open steel line that you removed the OEM hose from earlier. Secure with supplied screw clamp.

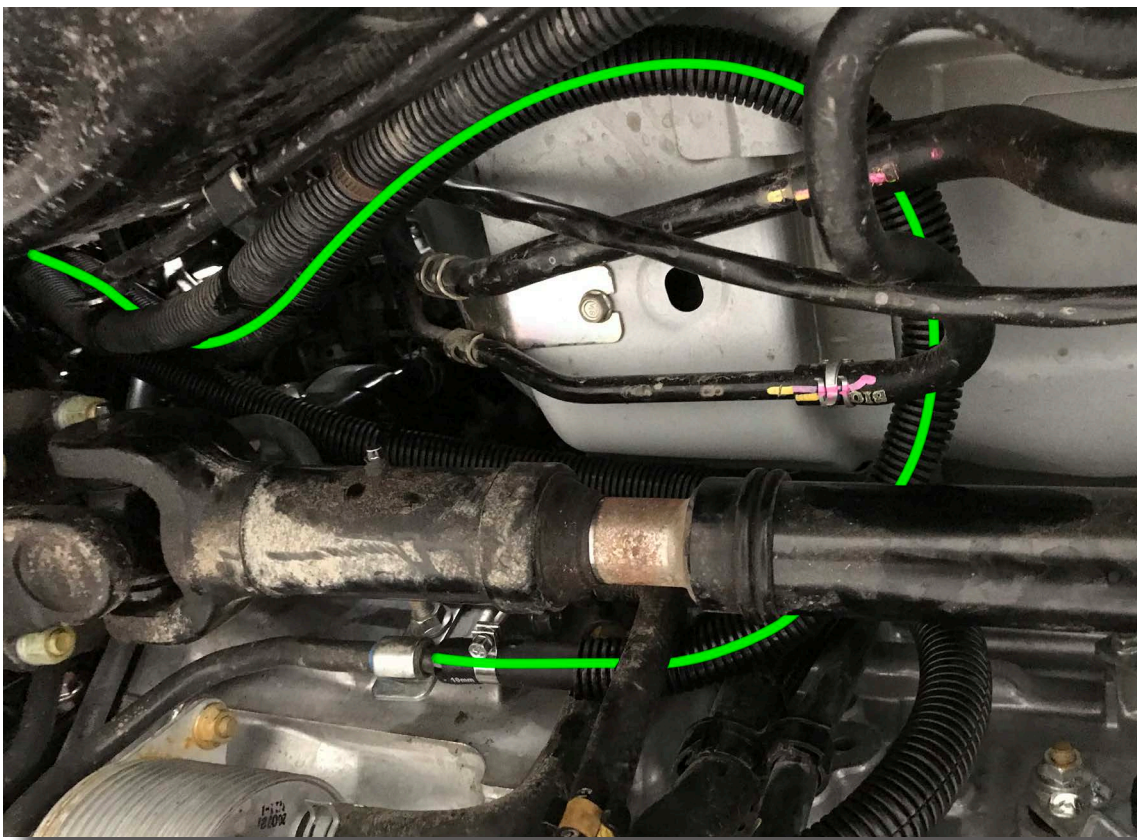

28. Finally, re-check all screw clamps are tight prior to starting the engine.

This Page applies to All Vehicles

29. Next we need to check the transmission fluid and top as required.
30. THE ENGINE MUST BE RUNNING WHILE CHECKING TRANSMISSION FLUID.
31. Before checking the fluid level, you need to allow the engine to run for at least one minute. This pumps the fluid that has drained into the pan back into the torque converter, cooler lines, and valve body.
32. In the transmission sump or pan, locate the check valve bolt - the bolt will have "Check" engraved into it.



33. With the **engine running**, remove using a 5mm Allen key. DO NOT remove the 14mm bolt located at the rear of the transmission pan as this is the drain plug.

This Page applies to All Vehicles

34. If there is no oil dribbling out of the check plug, locate and remove the 24mm fill plug on the drivers side of the transmission.

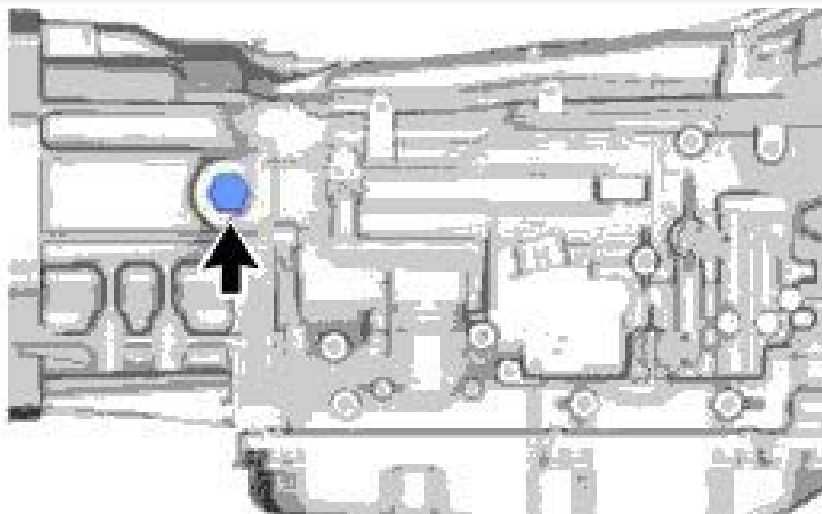

This Page applies to All Vehicles

35. Carefully top up the transmission fluid through the fill plug until the fluid is flowing out of the check plug hole. Once the flow drops to a dribble, quickly put the check plug back in and tighten. Re-install the 24mm fill plug.

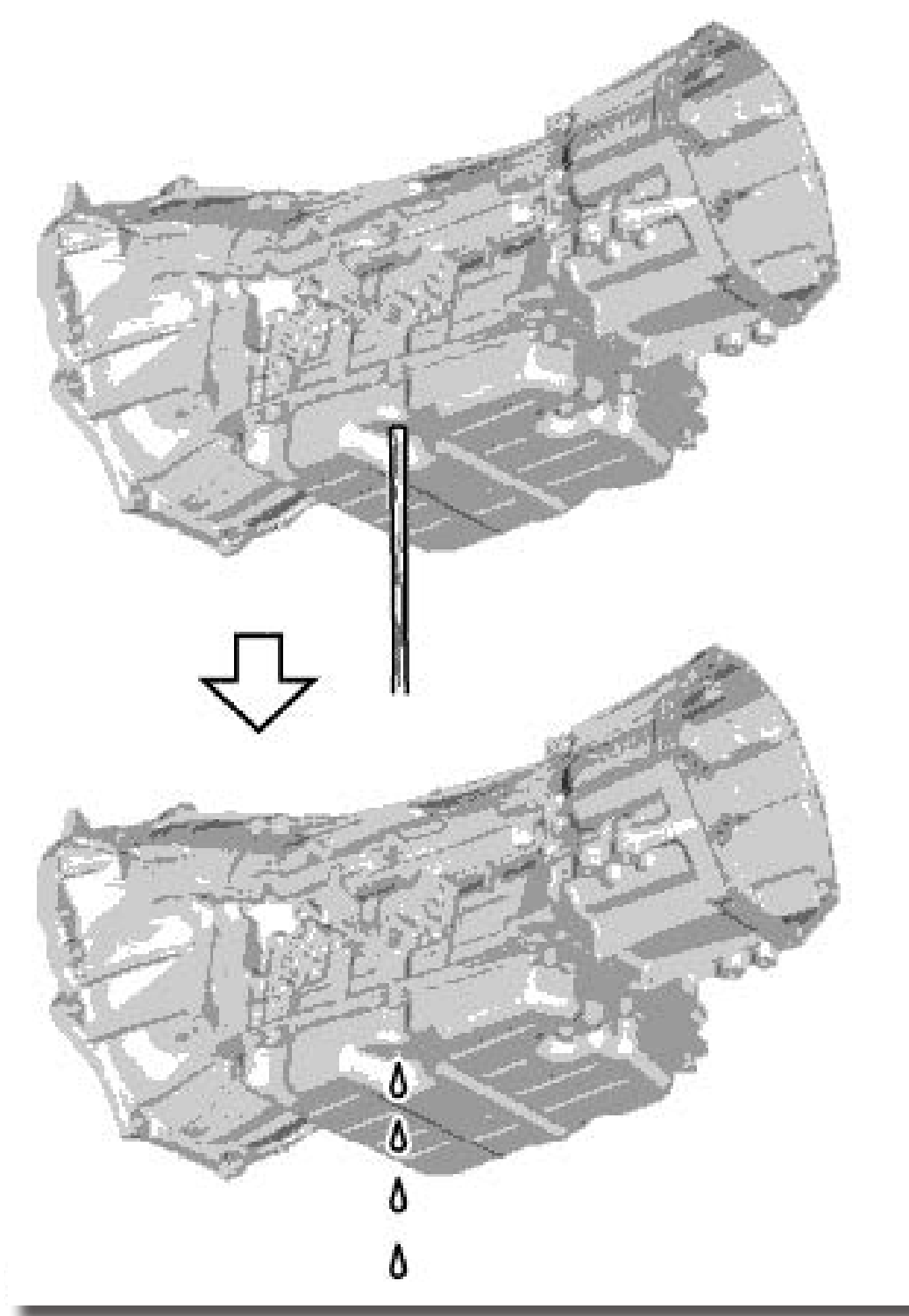

This Page applies to All Vehicles

36. Prior to road testing, check all connections for weeping or leaking of transmission fluid in case a screw clamp was left loose.
37. Clean all areas of the engine/underneath where transmission fluid may have spilt.
38. For Mazda BT50 Only: We recommend re-fitting the bumper prior to road testing. However, you may require partly removing bumper again after road testing if you find a connection weeping in order to tighten screw clamp.
39. Road test the vehicle. You are looking for anomalies such as high transmission fluid temperatures indicating fluid level is still too low / high or possibly an air lock or cooler line blockage. If transmission operates as expected then return to the workshop.
40. Do NOT switch off engine
41. With engine still running, visually check for leaks and re-tighten any fittings as required.
42. Continuing with the engine still running, recheck fluid level by repeating the steps 30 to 33.

**PLEASE NOTE: THE TRANSMISSION FLUID MAY BE QUITE HOT.
PLEASE TAKE CARE WHEN UNDOING CHECK PLUG BOLT.**

43. If the fluid is at the correct level, clean any transmission fluid off the vehicle.
44. Re-install front grill, radiator apron, bash plates and any other item that was removed during installation.

This completes the installation of the External Transmission Oil Cooler Kit to Suit Isuzu D-Max and Mazda BT50 with 6 Speed Automatic (Aug 2020)

Please remember ALL automatic transmissions have a service interval of 2 years or 40,000km to improve the longevity of the transmission.

Please Provide us with Feedback

If you have a minute to provide us with some feedback about your experience with Wholesale Automatic Transmissions and our products, that would be greatly appreciated.

Using your smart phone or device's camera app, point at the QR code below to take you straight to our feedback page for you to choose the most appropriate feedback method.

